

1W Isolated DC-DC converter
Fixed input voltage, unregulated dual/single output

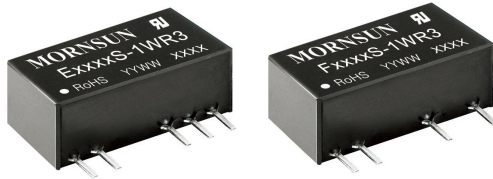

Continuous Short
Circuit Protection



UL 62368-1 EN 62368-1 BS EN 62368-1 CB RoHS Patent Protection
IEC 62368-1

E_S-1WR3 & F_S-1WR3 series are specially designed for applications where an isolated (two isolated) voltage is required in a distributed power supply system. They are suitable for: pure digital circuits, low frequency analog circuits, relay-driven circuits and data switching circuits.

FEATURES

- Continuous short-circuit protection
- No-load input current as low as 8mA
- Operating ambient temperature range: -40°C to +105°C
- High efficiency up to 81%
- I/O isolation test voltage: 3k VDC
- Industry standard pin-out

Selection Guide

Certification	Part No.	Input Voltage (VDC)	Output		Full Load Efficiency (%) Min./Typ.	Capacitive Load(μF) Max.*
		Nominal (Range)	Voltage (VDC)	Current (mA) Max./Min.		
--	F0909S-1WR3	9 (8.1-9.9)	9	111/12	77/81	470
UL/EN/BS EN/IEC	E1203S-1WR3	12 (10.8-13.2)	±3.3	±152/±15	71/75	1200
	E1205S-1WR3		±5	±100/±10	76/80	1200
--	E1209S-1WR3		±9	±56/±5	76/80	470
UL/EN/BS EN/IEC	E1212S-1WR3		±12	±42/±5	77/81	220
	E1215S-1WR3		±15	±34/±4	77/81	220
	E1224S-1WR3		±24	±21/±2	76/80	100
	F1203S-1WR3		3.3	303/30	71/75	2400
	F1205S-1WR3		5	200/20	76/80	2400
	F1209S-1WR3		9	111/12	76/80	1000
	F1212S-1WR3		12	83/9	76/80	560
	F1215S-1WR3		15	67/7	77/81	560
	F1224S-1WR3		24	42/5	77/81	220
	E1505S-1WR3	±5	±100/±10	76/80	1200	
--	E1509S-1WR3	±9	±56/±5	76/80	470	
UL/EN/BS EN/IEC	E1512S-1WR3	±12	±42/±5	76/80	220	
	E1515S-1WR3	±15	±34/±4	77/81	220	
--	E1524S-1WR3	±24	±21/±2	77/81	100	
UL/EN/BS EN/IEC	F1505S-1WR3	15 (13.5-16.5)	5	200/20	76/80	2400
	F1509S-1WR3		9	111/12	76/80	1000
	F1512S-1WR3		12	83/9	76/80	560
	F1515S-1WR3		15	67/7	77/81	560
			F1524S-1WR3	24	42/5	77/81
--	E2403S-1WR3	24 (21.6-26.4)	±3.3	±150/±15	72/76	1200
UL/EN/BS EN/IEC	E2405S-1WR3		±5	±100/±10	74/80	1200
--	E2409S-1WR3		±9	±56/±5	74/80	470
UL/EN/BS EN/IEC	E2412S-1WR3		±12	±42/±5	75/81	220
	E2415S-1WR3		±15	±34/±4	73/79	220
	E2424S-1WR3		±24	±21/±2	74/80	100

UL/EN/BS EN/IEC	Model	Output Voltage (V)	Output Current (A)	Power (W)	Efficiency (%)	Output Current (mA)
UL/EN/BS EN/IEC	F2403S-1WR3	24 (21.6-26.4)	3.3	303/30	69/75	2400
	F2405S-1WR3		5	200/20	73/79	2400
--	F2407S-1WR3	24 (21.6-26.4)	7.2	139/13	74/80	1000
UL/EN/BS EN/IEC	F2409S-1WR3		9	111/12	74/80	1000
	F2412S-1WR3		12	83/9	75/81	560
UL/EN/BS EN/IEC	F2415S-1WR3		15	67/7	75/81	560
	F2424S-1WR3	24	42/5	75/81	220	

Note: *The specified maximum capacitive load for positive and negative output is identical.

Input Specifications

Item	Operating Conditions	Min.	Typ.	Max.	Unit
Input Current (full load / no-load)	9V input	--	137/8	144/--	mA
	12V input	--	112/8	118/--	
	15V input	--	84/8	88/--	
	24V input	--	56/8	59/--	
Reflected Ripple Current*		--	15	--	
Surge Voltage(1sec. max.)	9V input	-0.7	--	12	VDC
	12VDC input	-0.7	--	18	
	15VDC input	-0.7	--	21	
	24VDC input	-0.7	--	30	
Input Filter		Capacitance filter			
Hot Plug		Unavailable			

Note: * Refer to DC-DC Converter Application Notes for detailed description of reflected ripple current test method.

Output Specifications

Item	Operating Conditions	Min.	Typ.	Max.	Unit	
Voltage Accuracy		See output regulation curves (Fig. 1)				
Linear Regulation	Input voltage change: ±1%	3.3VDC output	--	--	1.5	--
		Other output	--	--	1.2	
Load Regulation	10%-100% load	3.3VDC output	--	15	20	%
		5VDC output	--	10	15	
		Other output	--	8	10	
Ripple & Noise*	20MHz bandwidth	24VDC output	--	50	100	mVp-p
		Other output	--	30	75	
Temperature Coefficient	Full load	--	±0.02	--	%/°C	
Short-Circuit Protection		Continuous, self-recovery				

Note: * The "parallel cable" method is used for Ripple and Noise test, please refer to DC-DC Converter Application Notes for specific information.

General Specifications

Item	Operating Conditions	Min.	Typ.	Max.	Unit
Isolation	Input-output electric strength test for 1 minute with a leakage current of 1mA max.	3000	--	--	VDC
Insulation Resistance	Input-output resistance at 500VDC	1000	--	--	MΩ
Isolation Capacitance	Input-output capacitance at 100kHz/0.1V	--	20	--	pF
Operating Temperature	Derating when operating temperature ≥ 100°C, (see Fig. 2)	-40	--	105	°C
Storage Temperature		-55	--	125	
Case Temperature Rise	Ta=25°C	--	25	--	
Pin Soldering Resistance Temperature	Soldering spot is 1.5mm away from case for 10 seconds	--	--	300	

Storage Humidity	Non-condensing	5	--	95	%RH
Vibration		10-150Hz, 5G, 0.75mm. along X, Y and Z			
Switching Frequency	Full load, nominal input voltage	--	260	--	kHz
MTBF	MIL-HDBK-217F@25°C	3500	--	--	k hours

Mechanical Specifications

Case Material	Black plastic; flame-retardant and heat-resistant (UL94V-0)
Dimensions	19.65 x 6.00 x 10.16mm
Weight	2.1g(Typ.)
Cooling Method	Free air convection

Electromagnetic Compatibility (EMC)

Emissions	CE	CISPR32/EN55032	CLASS B
	RE	CISPR32/EN55032	CLASS B
Immunity	ESD	IEC/EN61000-4-2	Air ±8kV, Contact ±6kV perf. Criteria B

Note: Refer to Fig. 4 for recommended circuit test.

Typical Performance Curves

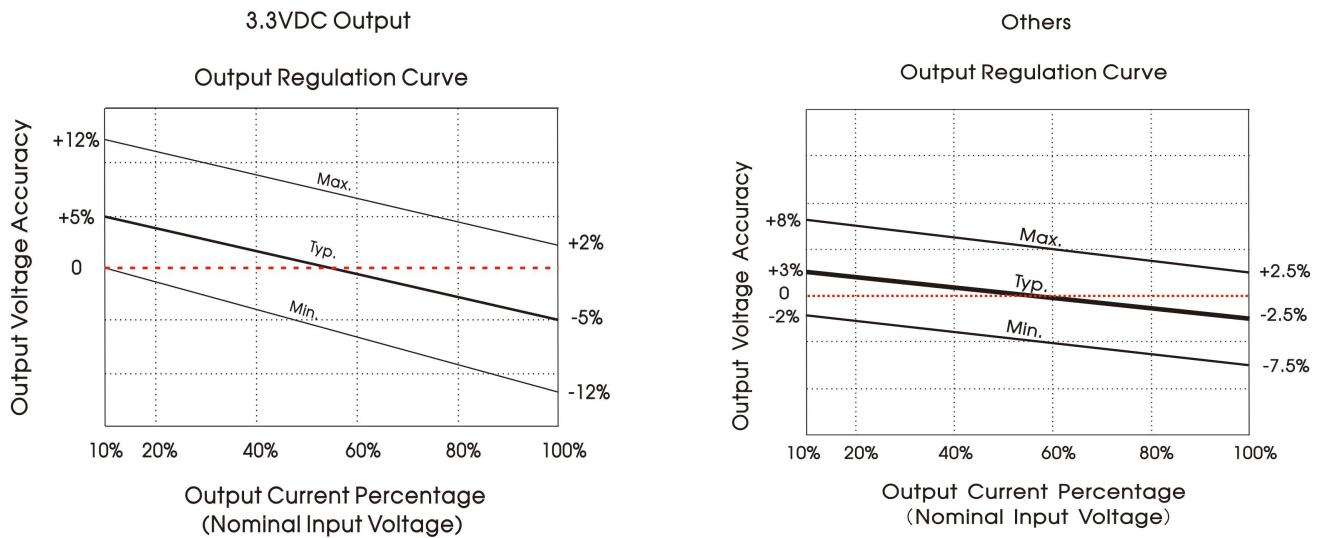

Fig. 1

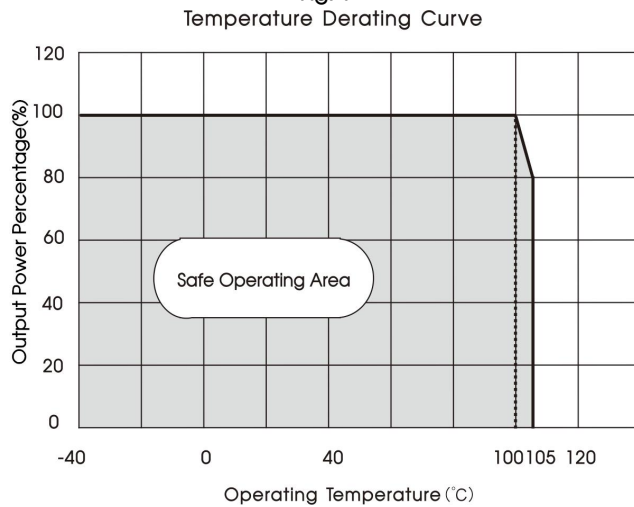
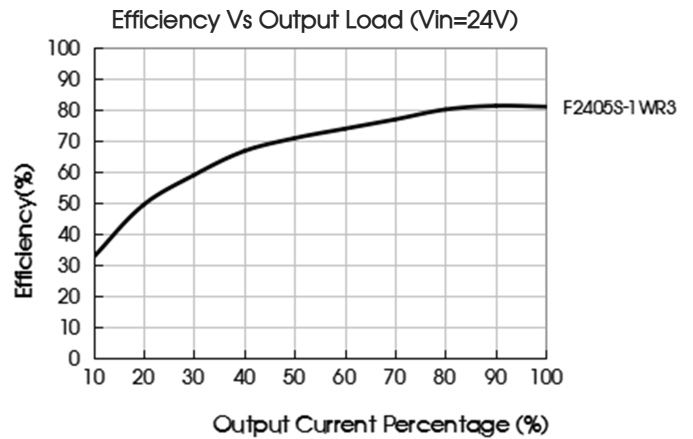
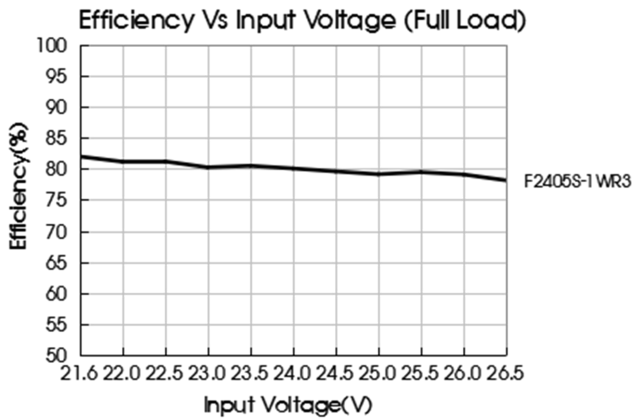
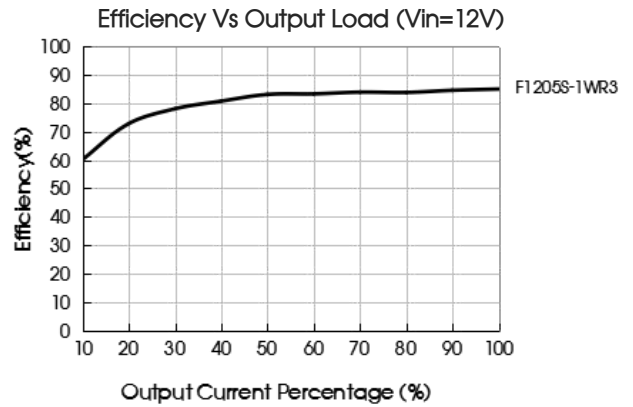
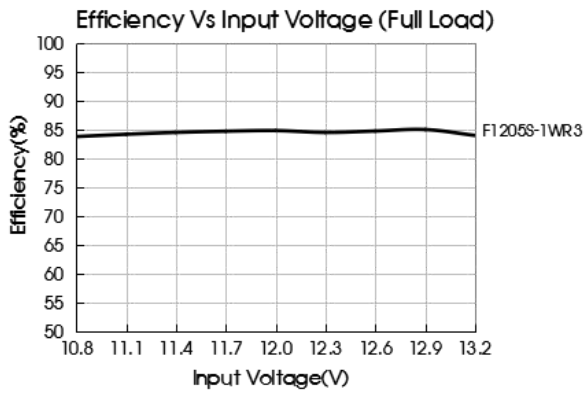

Fig. 2



Design Reference

1. Typical application

Input and/or output ripple can be further reduced, by connecting a filter capacitor from the input and/or output terminals to ground as shown in Fig. 3.

Choosing suitable filter capacitor values is very important for a smooth operation of the modules, particularly to avoid start-up problems caused by capacitor values that are too high. For recommended input and output capacitor values refer to Table 1.

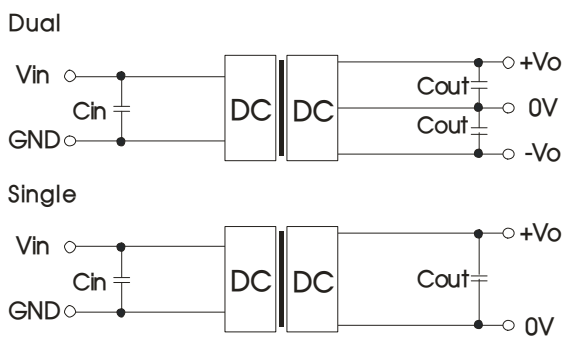

Fig. 3

Table 1: Recommended input and output capacitor values

Vin	Cin	Single output	Cout	Dual output	Cout
9VDC	2.2μF/25V	3.3VDC	10μF/16V	±3.3VDC	4.7μF/16V
12VDC	2.2μF/25V	5VDC	10μF/16V	±5VDC	4.7μF/16V
15VDC	2.2μF/25V	7.2VDC	2.2μF/16V	±9VDC	1μF/16V
24VDC	1μF/50V	9VDC	2.2μF/16V	±12VDC	1μF/25V
--	--	12VDC	2.2μF/25V	±15VDC	0.47μF/25V
--	--	15VDC	1μF/25V	±24VDC	0.47μF/50V
--	--	24VDC	1μF/50V	--	--

2. EMC compliance circuit

Dual

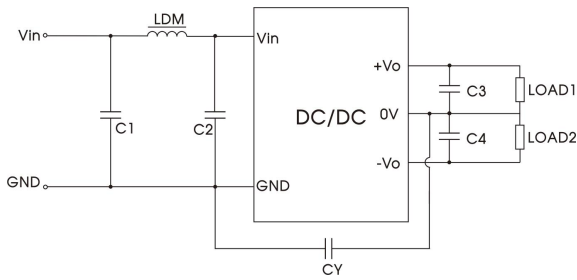

Single

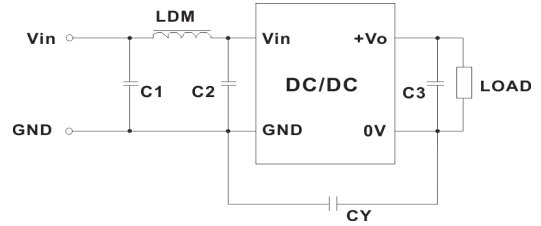

Fig. 4

Table 2: EMC recommended circuit value table

Emissions	C1/C2	4.7μF /50V
	CY	270pF /3kVDC
	C3/C4	Refer to the Cout in table 1
	LDM	6.8μH

3. For additional information please refer to DC-DC converter application notes on

www.mornsun-power.com

Dimensions and Recommended Layout

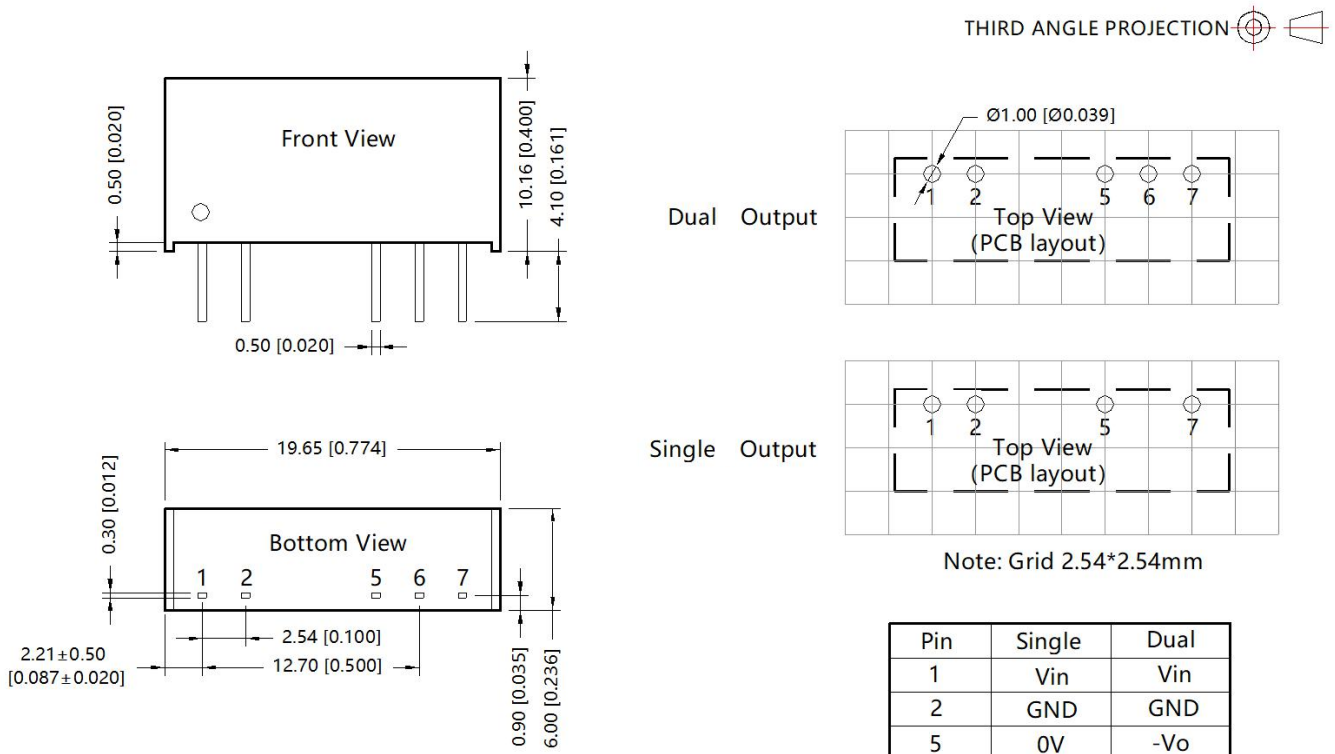

Note:
Unit: mm[inch]
Pin section tolerances: ±0.10[±0.004]
General tolerances: ±0.25[±0.010]

Pin	Single	Dual
1	Vin	Vin
2	GND	GND
5	0V	-Vo
6	No Pin	0V
7	+Vo	+Vo

Notes:

1. For additional information on Product Packaging please refer to www.mornsun-power.com. Tube Packaging bag number: 58200001;
2. If the product is not operated within the required load range, the product performance cannot be guaranteed to comply with all parameters in the datasheet;
3. The maximum capacitive load offered were tested at input voltage range and full load;
4. Unless otherwise specified, parameters in this datasheet were measured under the conditions of $T_a=25^{\circ}\text{C}$, humidity<75%RH with nominal input voltage and rated output load;
5. All index testing methods in this datasheet are based on our company corporate standards;
6. We can provide product customization service, please contact our technicians directly for specific information;
7. Products are related to laws and regulations: see "Features" and "EMC";
8. Our products shall be classified according to ISO14001 and related environmental laws and regulations, and shall be handled by qualified units.

MORNSUN Guangzhou Science & Technology Co., Ltd.

Address: No. 5, Kehui St. 1, Kehui Development Center, Science Ave., Guangzhou Science City, Huangpu District, Guangzhou, P. R. China
Tel: 86-20-38601850 Fax: 86-20-38601272 E-mail: info@mornsun.cn www.mornsun-power.com