



2SA1015

PNP SILICON TRANSISTOR

LOW FREQUENCY PNP AMPLIFIER TRANSISTOR

■ FEATURES

- * Collector-Emitter Voltage: $BV_{CEO} = -50V$
- * Collector Current up to 150mA
- * High h_{FE} Linearity
- * Complement to UTC 2SC1815

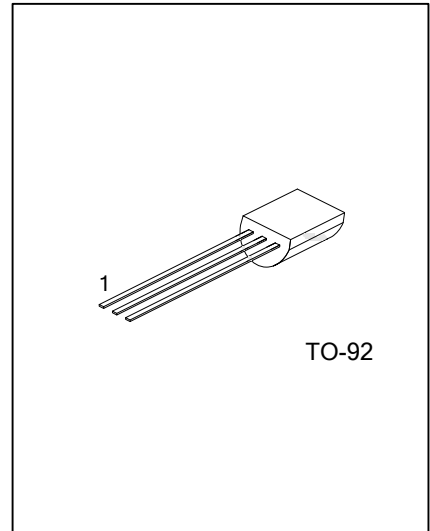

■ ORDERING INFORMATION

Ordering Number		Package	Pin Assignment			Packing
Lead Free Plating	Halogen Free		1	2	3	
2SA1015L-xx-T92-B	2SA1015G-xx-T92-B	TO-92	E	C	B	Tape Box
2SA1015L-xx-T92-K	2SA1015G-xx-T92-K	TO-92	E	C	B	Bulk

Note: Pin Assignment: E: Emitter C: Collector B: Base

<p>2SA1015L-xx-T92-B</p>	<p>(1) B: Tape Box, K: Bulk</p> <p>(2) T92: TO-92</p> <p>(3) xx: refer to Classification of h_{FE}</p> <p>(4) L: Lead Free, G: Halogen Free</p>
--------------------------	--

■ MARKING

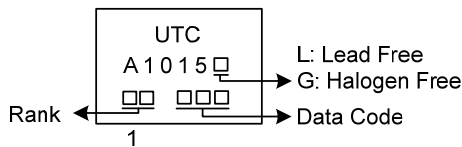

■ ABSOLUTE MAXIMUM RATING ($T_A=25^\circ\text{C}$, unless otherwise specified)

PARAMETER	SYMBOL	RATINGS	UNIT
Collector-Base Voltage	V_{CBO}	-50	V
Collector-Emitter Voltage	V_{CEO}	-50	V
Emitter-Base Voltage	V_{EBO}	-5	V
Collector Current	I_C	-150	mA
Base Current	I_B	-50	mA
Collector Dissipation	P_C	400	mW
Junction Temperature	T_J	125	$^\circ\text{C}$
Storage Temperature	T_{STG}	-55 ~ +125	$^\circ\text{C}$

Note: Absolute maximum ratings are those values beyond which the device could be permanently damaged.

Absolute maximum ratings are stress ratings only and functional device operation is not implied.

■ ELECTRICAL CHARACTERISTICS ($T_A=25^\circ\text{C}$, unless otherwise specified)

PARAMETER	SYMBOL	TEST CONDITIONS	MIN	TYP	MAX	UNIT
Collector-Base Breakdown Voltage	BV_{CBO}	$I_C=-100\mu\text{A}, I_E=0$	-50			V
Collector-Emitter Breakdown Voltage	BV_{CEO}	$I_C=-10\text{mA}, I_B=0$	-50			V
Emitter-Base Breakdown Voltage	BV_{EBO}	$I_E=-10\mu\text{A}, I_C=0$	-5			V
Collector Cut-off Current	I_{CBO}	$V_{CB}=-50\text{V}, I_E=0$			-100	nA
Emitter Cut-off Current	I_{EBO}	$V_{EB}=-5\text{V}, I_C=0$			-100	nA
DC Current Gain	h_{FE1}	$V_{CE}=-6\text{V}, I_C=-2\text{mA}$	120		700	
	h_{FE2}	$V_{CE}=-6\text{V}, I_C=-150\text{mA}$	25			
Collector-Emitter Saturation Voltage	$V_{CE(SAT)}$	$I_C=-100\text{mA}, I_B=-10\text{mA}$		-0.1	-0.3	V
Base-Emitter Saturation Voltage	$V_{BE(SAT)}$	$I_C=-100\text{mA}, I_B=-10\text{mA}$			-1.1	V
Output Capacitance	C_{OB}	$V_{CB}=-10\text{V}, I_E=0, f=1\text{MHz}$		4.0	7.0	pF
Current Gain Bandwidth Product	f_T	$V_{CE}=-10\text{V}, I_C=-1\text{mA}$	80			MHz
Noise Figure	NF	$V_{CE}=-6\text{V}, I_C=-0.1\text{mA}, R_G=1\text{k}\Omega, f=100\text{Hz}$		0.5	6	dB

■ CLASSIFICATION OF h_{FE1}

RANK	Y	GR	BL
RANGE	120-240	200-400	350-700

■ TYPICAL CHARACTERISTICS

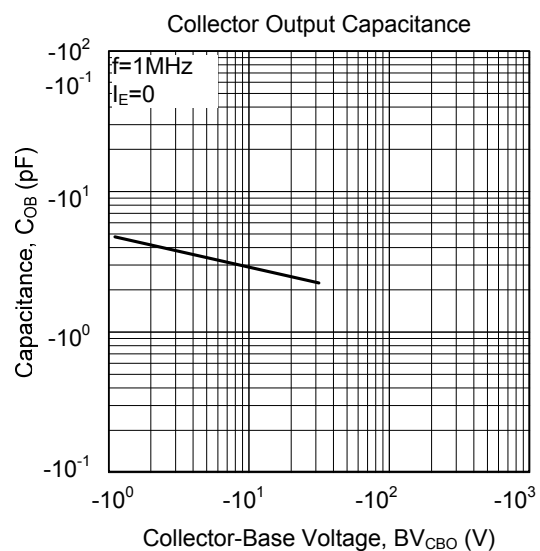
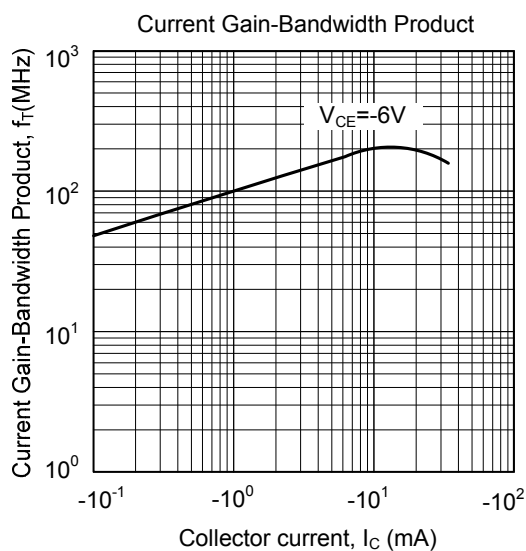
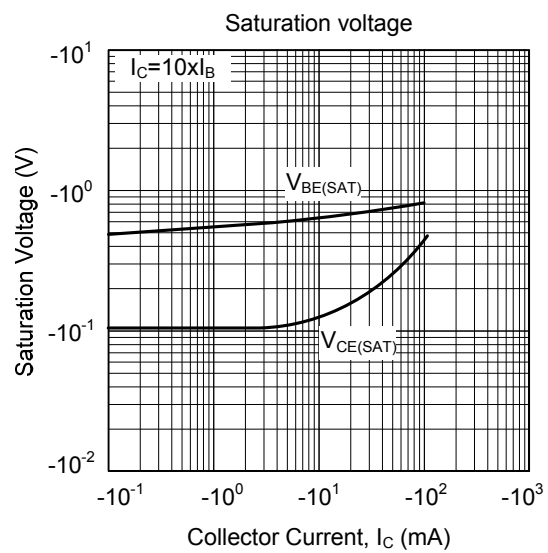
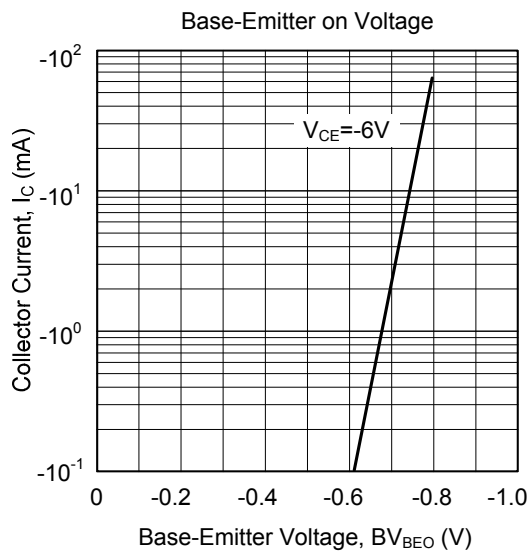
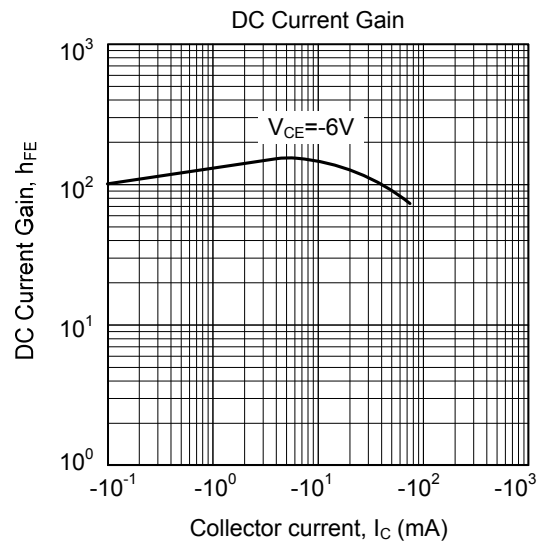
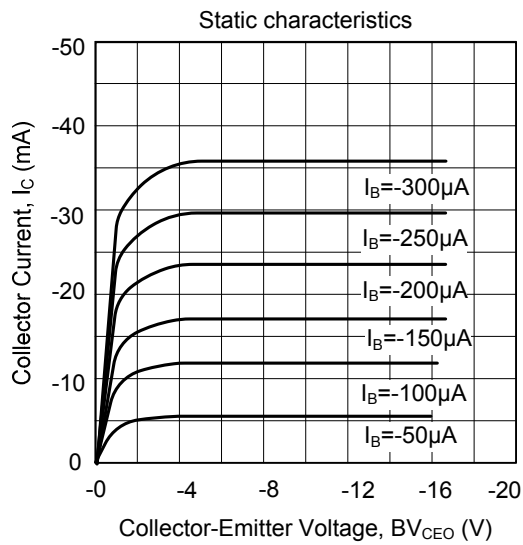

UTC assumes no responsibility for equipment failures that result from using products at values that exceed, even momentarily, rated values (such as maximum ratings, operating condition ranges, or other parameters) listed in products specifications of any and all UTC products described or contained herein. UTC products are not designed for use in life support appliances, devices or systems where malfunction of these products can be reasonably expected to result in personal injury. Reproduction in whole or in part is prohibited without the prior written consent of the copyright owner. The information presented in this document does not form part of any quotation or contract, is believed to be accurate and reliable and may be changed without notice.