

Wide input voltage, non-isolated & regulated single output



## FEATURES

- High efficiency up to 95%
- No-load input current as low as 0.2mA
- Operating temperature range: -40°C to +85°C
- Support the negative output
- Output short circuit protection
- Pin-out compatible with LM78XX linear regulators
- UL60950, EN60950 approval

K78xx-500R3 series are high efficiency switching regulators and ideal substitutes of LM78xx series three-terminal linear regulators. The product is featured with high efficiency, low loss, short circuit protection, support the negative output and no heat sink requirement. They are widely used in industrial control, instrumentation, and electric power applications.

## Selection Guide

Certification	Part Number	Input Voltage (VDC)	Output		Efficiency (%/Typ.) (Min. Vin)/ (Max. Vin) @Full Load	Max. Capacitive Load(μF)
		Nominal (Range)	Output Voltage (VDC)	Max. Output Current (mA)		
UL/CE	K7803-500R3	24 (4.75-36)	3.3	500	86/80	680
	K7805-500R3	24 (6.5-36)	5.0	500	90/84	680
		12 (7-31)	-5.0	-300	80/81	330
	K7809-500R3	24 (12-36)	9	500	93/90	680
	K7812-500R3	24 (15-36)	12	500	94/91	680
		12 (8-24)	-12	-150	84/85	330
	K7815-500R3	24 (19-36)	15	500	95/93	680
		12 (8-21)	-15	-150	85/87	330

Note: For input voltage higher than 30 VDC, a 22μF/50V input capacitor is required.

## Input Specifications

Item	Operating Conditions	Min.	Typ.	Max.	Unit
No-load Input Current	Positive output	--	0.2	1.5	mA
Reverse Polarity Input		Forbidden			
Input Filter		Capacitor filter			

## Output Specifications

Item	Operating Conditions	Min.	Typ.	Max.	Unit	
Output Voltage Accuracy	Full load, input voltage range	K7803-500R3	--	±2	±4	%
		Others	--	±2	±3	
Line Regulation	Full load, input voltage range	--	±0.2	±0.4	%	
Load Regulation	Nominal input voltage, 10% -100% load	--	±0.4	±0.6		
Ripple & Noise*	20MHz bandwidth, nominal input voltage, 10% -100% load	--	20	75	mVp-p	
Temperature Coefficient	Operating temperature -40°C to +85°C	--	--	±0.03	%/°C	
Transient response deviation	Nominal input voltage, 25% load step change	--	50	250	mV	
Transient recovery time		--	0.2	1	ms	
Output short circuit protection	Nominal input voltage	Continuous, self-recovery				

Note: \*1. Ripple and noise tested with "parallel cable" method, please refer to DC-DC Converter Application Notes for specific operation methods;

\*2. With the load lower than 10%, the maximum ripple and noise of 3.3V/5V output products will be 150mVp-p, 9V/12V/15V output products will be 2%Vo.

General Specifications

Item	Operating Conditions	Min.	Typ.	Max.	单位
Operating Temperature	see Fig. 1	-40	--	+85	°C
Storage Temperature		-55	--	+125	
Pin Welding Resistance Temperature	Welding time: 10s (Max.)	--	--	+260	
Storage Humidity	Non-condensing	5	--	95	%RH
Switching Frequency	Full load, nominal input voltage	550	--	850	KHz
MTBF	MIL-HDBK-217F@25°C	2000	--	--	K hours

Physical Specifications

Casing Material	Black flame-retardant and heat-resistant plastic (UL94 V-0)
Package Dimensions	11.60*7.55*10.16 mm
Weight	1.8g (Typ.)
Cooling Method	Free air convection

EMC Specifications

EMI	CE	CISPR22/EN55022	CLASS B (see Fig. 5-② for recommended circuit)	
	RE	CISPR22/EN55022	CLASS B (see Fig. 5-② for recommended circuit)	
EMS	ESD	IEC/EN 61000-4-2	Contact ±4KV	perf. Criteria B
	RS	IEC/EN 61000-4-3	10V/m	perf. Criteria A
	EFT	IEC/EN 61000-4-4	±1KV (see Fig. 5-① for recommended circuit)	perf. Criteria B
	Surge	IEC/EN 61000-4-5	line to line ±1KV (see Fig. 5-① for recommended circuit)	perf. Criteria B
	CS	IEC/EN 61000-4-6	3Vr.m.s	perf. Criteria A

Product Characteristic Curve

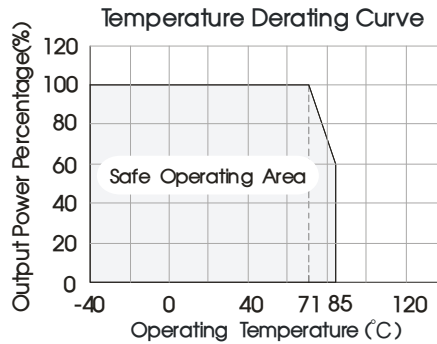
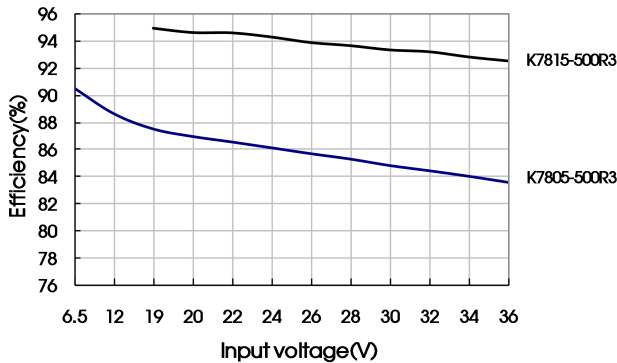
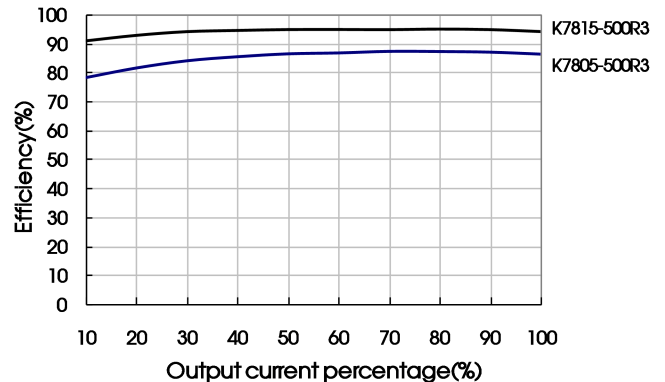

Fig. 1

Positive output efficiency Vs input voltage (full load)



Positive output efficiency Vs output load (Vin=Vin-nominal)



Negative output efficiency Vs input voltage (full load)

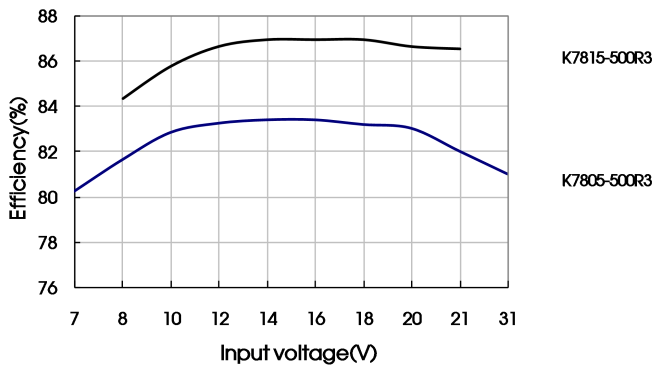

Negative output efficiency Vs output load (Vin=Vin-nominal)

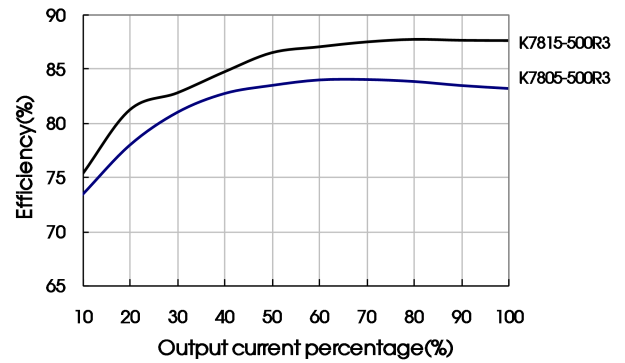

Design Reference

1. Typical application circuit

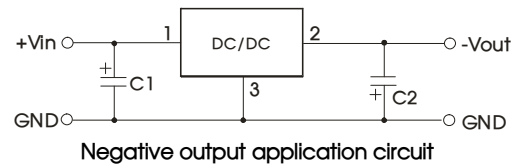
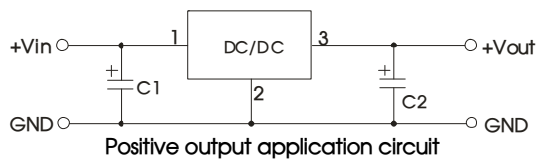
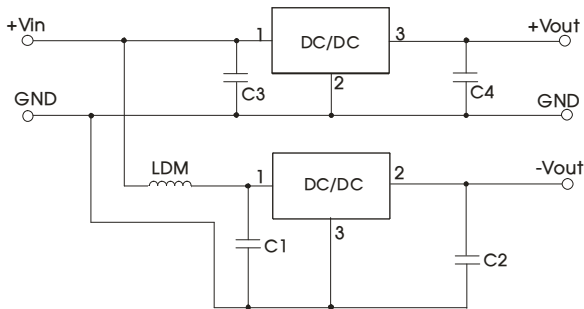

Fig. 2 Typical application circuit



Sheet 1		
Part No.	C1/C3 (ceramic capacitor)	C2/C4 (ceramic capacitor)
K7803-500R3	10μF/50V	22μF/10V
K7805-500R3		22μF/10V
K7809-500R3		22μF/16V
K7812-500R3		22μF/25V
K7815-500R3		22μF/25V

Fig. 3 Positive and Negative output paralleling application circuit

- Note:
- C1 and C2 (C3 and C4) are required and should be connected close to the pin terminal of the module.
  - The capacitance of C1 and C2 (C3 and C4) refer to Sheet 1, it can be increased properly if required, and tantalum or low ESR electrolytic capacitors may also suffice.
  - When the products used as the circuit like figure 3, an inductor named as LDM up to 10μH is recommended in the circuit to reduce the mutual interference.
  - Cannot be used in parallel for output and hot swap.

To reduce the output ripple furtherly, it is suggested to connect a "LC" filter at the output terminal, and recommended value of L is 10μH-47μH.

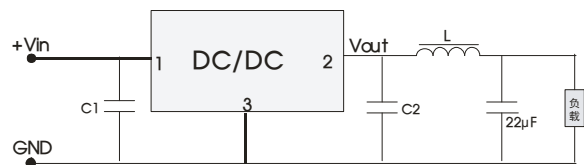
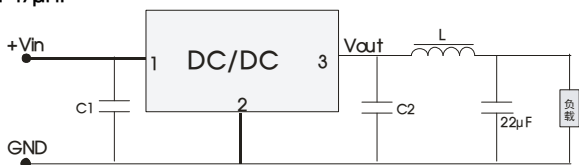

Positive output

Negative output

Fig. 4 "LC" filter application circuit

2. EMC solution-recommended circuit

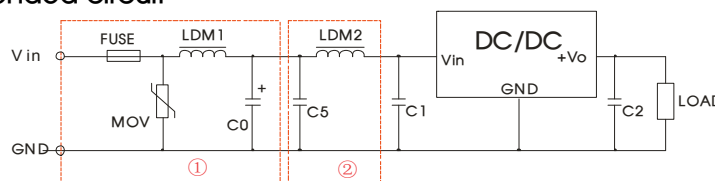

Fig. 5 EMC recommended circuit

FUSE	MOV	LDM1	C0	C1/C2	C5	LDM2
Selected based on the actual input current from the customer	S20K30	82μH	680μF /50V	Refer to Sheet 1	4.7μF /50V	12μH

Note: Part ① in the Fig. 5 is for EMS test, part ② is for EMI filtering; parts ① and ② can be added based on actual requirement.

3. For more information please find the application notes on [www.mornsun-power.com](http://www.mornsun-power.com)

## Dimensions and Recommended Layout

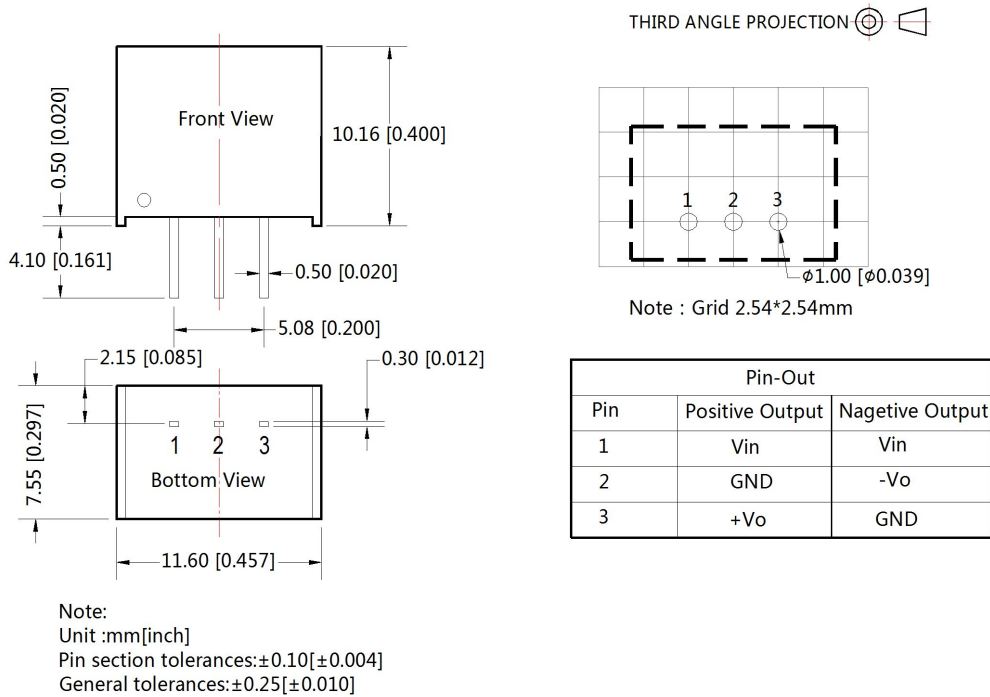

### Notes:

1. Packing information please refer to Product Packing Information which can be downloaded from [www.mornsun-power.com](http://www.mornsun-power.com). Packing bag number:58200003;
2. The max. capacitive load should be tested within the input voltage range and under full load conditions;
3. Unless otherwise specified, data in this datasheet should be tested under the conditions of Ta=25°C, humidity<75%RH when inputting nominal voltage and outputting rated load;
4. All index testing methods in this datasheet are based on our Company's corporate standards;
5. The performance indexes of the product models listed in this manual are as above, but some indexes of non-standard model products will exceed the above-mentioned requirements, and please directly contact with our technician for specific information;
6. Specifications of this product are subject to changes without prior notice.

## MORNSUN Guangzhou Science & Technology Co., Ltd.

Address: No. 5, Kehui St. 1, Kehui Development Center, Science Ave., Guangzhou Science City, Luogang District, Guangzhou, P. R. China  
Tel: 86-20-38601850-8801 Fax: 86-20-38601272 E-mail: [info@mornsun.cn](mailto:info@mornsun.cn)