

15W, AC-DC converter



UL US CE CB RoHS

FEATURES

- Universal input range:85~264VAC, 50/60Hz
- Regulated output, low ripple and noise
- Efficiency up to 84%
- Over-current, short circuit and over-voltage protection
- Plastic case, meets UL94V-0
- Meet UL60950, IEC60950,EN60950 standards
- 3 years product warranty
- PCB mounting, Chassis mounting, DIN-Rail mounting

LH15 series —a compact size power converter offered by Mornsun. It features universal input voltage, taking both DC and AC input voltage, low power consumption, high efficiency, high reliability, safer isolation. It offers good EMC performance, which meet IEC/EN61000-4, CISPR22/EN55022, UL60950 and EN60950 standards, and it's widely used in industrial, office and civil applications. For harsh EMC environment, the application circuit in the datasheet is strongly recommended.

Selection Guide

Certification	Part No.*	Output Power	Nominal Output Voltage and Current		Efficiency (230VAC, %/Typ.)	Max. Capacitive Load(μF)	
			(Vo1/Io1)	(Vo2/Io2)		Vo1	Vo2
UL/CE/CB	LH15-10B03	9.9W	3.3V/3000mA	--	73	36000	--
	LH15-10B05	14W	5V/2800mA	--	76	20000	--
	LH15-10B09		9V/1600mA	--	78	8000	--
	LH15-10B12		12V/1250mA	--	80	5200	--
	LH15-10B15		15V/1000mA	--	80	5000	--
	LH15-10B24		24V/625mA	--	84	900	--
--	LH15-10A05	15W	+5V/1500mA	-5V/1500mA	76	12800	12800
	LH15-10A12		+12V/650mA	-12V/650mA	81	2350	2350
	LH15-10A15		+15V/500mA	-15V/500mA	83	3120	3120
	LH15-10A24		+24V/310mA	-24V/310mA	83	400	400
	LH15-10C0505-05		5V/2000mA	±5V/500mA	75	10800	2160
	LH15-10C0512-02		5V/2000mA	±12V/200mA	77	17280	2160
	LH15-10C0515-02		5V/1800mA	±15V/200mA	78	5920	370
	LH15-10C0524-01		5V/2000mA	±24V/100mA	78	1600	130
	LH15-10D0505-08		5V/2200mA	5V/800mA	78	15000	3000
	LH15-10D0512-04		5V/2000mA	12V/400mA	80	12000	1800
	LH15-10D0515-03		5V/2000mA	15V/300mA	81	10000	1500
	LH15-10D0524-02		5V/2000mA	24V/200mA	81	13000	800

Note: *About LH15-10AXX, use both positive and negative output as sampling feedback; and all others use Vo1 as sampling feedback.

Input Specifications

Item	Operating Conditions	Min.	Typ.	Max.	Unit
Input Voltage Range	AC input	85	--	264	VAC
	DC input	100	--	370	VDC
Input frequency		47	--	63	Hz
Input current	115VAC	--	--	0.37	A
	230VAC	--	--	0.22	
Inrush current	115VAC	--	10	--	

	230VAC	--	20	--	
Leakage current		0.3mA RMS typ./230VAC/50Hz			
Recommended External Input Fuse(Special package series include fuse)		2A/250V, slow fusing			
Hot Plug		Unavailable			

Output Specifications

Item	Operating Conditions		Min.	Typ.	Max.	Unit	
Output Voltage Accuracy	Main circuit	3.3V Output	--	±3	--		
		Others output	--	±2	--		
Line Regulation	Full load	Main circuit	--	±0.5	--		
		Auxiliary circuit	--	±1.5	--		
Load Regulation	0%-100% load	Single output	--	±1	--	%	
	10%-100% load	Dual output(balanced load)		--	±2		--
		Isolated triple output (balanced load)	Main circuit Vo1	--	±3		--
			Auxiliary circuit ±Vo2	--	±5		--
		Isolated and separated twin output (balanced load)	Main circuit Vo1	--	±3		--
Auxiliary circuit Vo2	--		±5	--			
Ripple & Noise*	Main circuit	20MHz bandwidth (peak-peak value)		--	50	100	mV
Temperature Coefficient	Main circuit		--	±0.02	--	%/°C	
Short Circuit Protection			Continuous, self-recovery				
Over-current Protection			≥110%Io self-recovery				
Over-voltage Protection	Main circuit	3.3 / 5VDC Output		≤7.5VDC			
		9VDC Output		≤13VDC			
		12 / 15VDC Output		≤20VDC			
		24VDC Output		≤30VDC			
Min. Load	Single output		0	--	--	%	
	Dual output (balanced load)		10	--	--		
	Isolated and separated twin output (balanced load)		10	--	--		
	Isolated triple output (balanced load)		10	--	--		
Hold-up Time	115VAC input		--	15	--	ms	
	230VAC input		--	80	--		

Note: * Ripple and noise are measured by "parallel cable" method, please see AC-DC Converter Application Notes for specific operation.

General Specifications

Item	Operating Conditions		Min.	Typ.	Max.	Unit
Isolation Voltage	Input-output	Test time: 1min	3000	--	--	VAC
	Input-ground		2000	--	--	
Operating Temperature	Single output, Isolated and separated twin output		-40	--	+70	°C
	Dual output, Isolated triple output		-25	--	+70	
Storage Temperature	Single output, Isolated and separated twin output		-40	--	+105	
	Dual output, Isolated triple output		-25	--	+105	
Storage Humidity			--	--	95	%RH
Welding Temperature	Wave-soldering		260±5°C; time:5~10s			
	Manual-welding		360±10°C; time:3~5s			
Switching Frequency				65		kHz
Power Derating	-40°C~-10°C(Single output, Isolated and separated twin output)		2.0	--	--	%/°C
	-25°C~-10°C(Dual output, Isolated triple output)		2.0	--	--	
	55°C~+70°C	Single output, Isolated and separated twin output	4.0	--	--	

		Dual output, Isolated triple output	3.75	--	--	
Safety Standard			IEC60950/EN60950/UL60950			
Safety Certification			IEC60950/EN60950/UL60950			
Safety Class	Single output		CLASS II			
	Other series		CLASS I			
MTBF			MIL-HDBK-217F@25°C > 300,000 h			

Physical Specifications

Casing Material		Black flame-retardant and heat-resistant plastic (UL94-V0)
Dimension	Horizontal package	62.00*45.00* 22.50mm
	A2 chassis mounting	96.10*54.00*31.00mm
	A3 chassis mounting	99.00*54.00*31.00 mm
	A4 Din-Rail mounting	96.10*54.00*35.60 mm
Weight	Horizontal package/A2 chassis mounting /A3 chassis mounting/A4 Din-Rail mounting	85g/135g/135g/175g(Typ.)
Cooling method		Free air convection

EMC Specifications

EMI	CE	CISPR22/EN55022, CLASS B (Without External Circuit)		
	RE	CISPR22/EN55022, CLASS B (Without External Circuit)		
EMS	ESD	IEC/EN61000-4-2	±6KV/±8KV	Perf. Criteria B
	RS	IEC/EN61000-4-3	10V/m	perf. Criteria A
	EFT	IEC/EN61000-4-4	±2KV (Without External Circuit)	perf. Criteria B
		IEC/EN61000-4-4	±4KV (See Fig. 5 for recommended circuit)	perf. Criteria B
	Surge	IEC/EN61000-4-5	±1KV/±2KV(Without External Circuit)	perf. Criteria B
IEC/EN61000-4-5		±2KV/4KV (See Fig. 5 for recommended circuit)	perf. Criteria B	
EMS	CS	IEC/EN61000-4-6	10 Vr.m.s	perf. Criteria A
	PFM	IEC/EN61000-4-8	10A/m	perf. Criteria A
	Immunities of voltage dip, drop and short interruption	IEC/EN61000-4-11	0%-70%	perf. Criteria B

Product Characteristic Curve

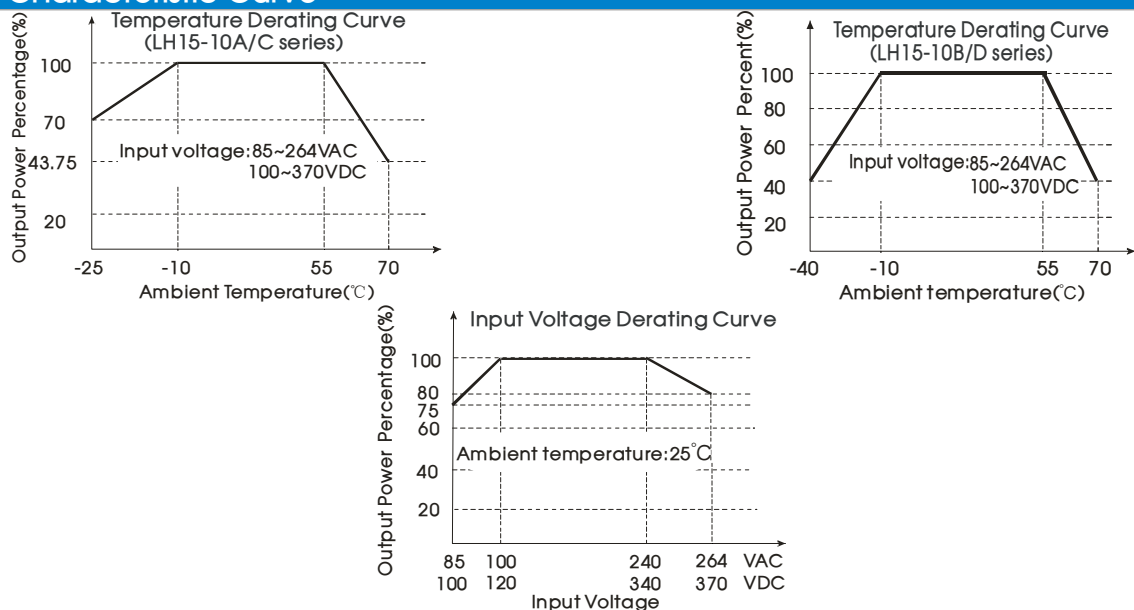

Note: ① When input 85~100VAC/240~264VAC/100~120VDC/340~370VDC, it need to be voltage derated on basis of temperature derating;
 ② This product is suitable for use in natural air cooling environments, if in a closed environment, please contact our company's FAE.

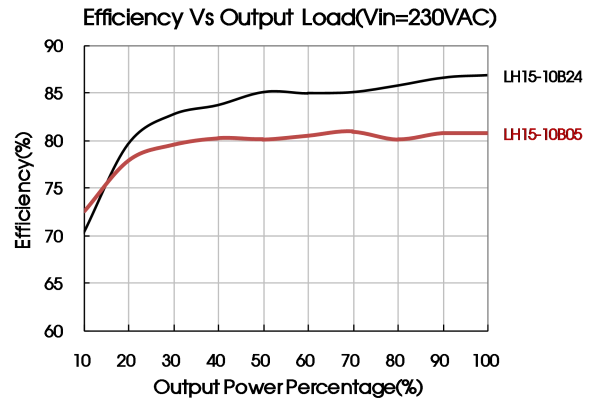
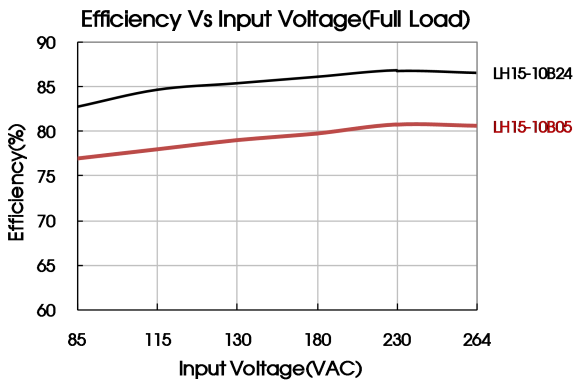

Design Reference

1. Typical application circuit

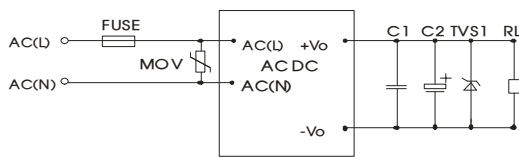

Fig. 1: Typical application circuit

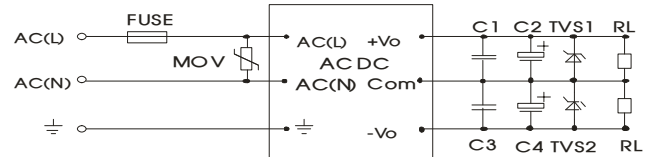

Fig. 2: LH15-10Axx (Dual Output) series typical application circuit

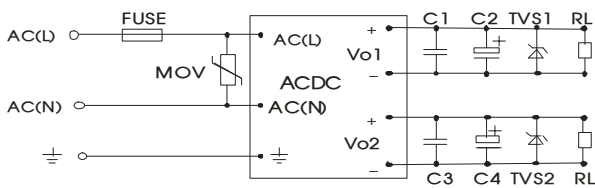

Fig. 3: LH15-10Dxx (Isolate Twin Output) series typical application circuit

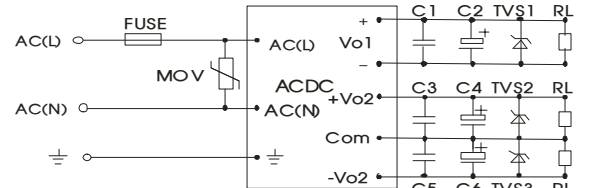

Fig. 4: LH15-10Cxx (Triple Output) series typical application circuit

Model	C2(μF)	C4(μF)	C6(μF)	TVS1	TVS2	TVS3
LH15-10B03	680			SMBJ7.0A		
LH15-10B05	680			SMBJ7.0A		
LH15-10B09	470			SMBJ12A		
LH15-10B12	220			SMBJ20A		
LH15-10B15	220			SMBJ20A		
LH15-10B24	68			SMBJ30A		
LH15-10A05	470	470		SMBJ7.0A	SMBJ7.0A	
LH15-10A12	220	220		SMBJ20A	SMBJ20A	
LH15-10A15	120	120		SMBJ20A	SMBJ20A	
LH15-10A24	68	68		SMBJ30A	SMBJ30A	
LH15-10C0505-05	470	220	220	SMBJ7.0A	SMBJ7.0A	SMBJ7.0A
LH15-10C0512-02	470	120	120	SMBJ7.0A	SMBJ20A	SMBJ20A
LH15-10C0515-02	470	120	120	SMBJ7.0A	SMBJ20A	SMBJ20A
LH15-10C0524-01	470	120	120	SMBJ7.0A	SMBJ30A	SMBJ30A
LH15-10D0505-08	470	470		SMBJ7.0A	SMBJ7.0A	
LH15-10D0512-04	470	220		SMBJ7.0A	SMBJ20A	
LH15-10D0515-03	470	120		SMBJ7.0A	SMBJ20A	
LH15-10D0524-02	470	47		SMBJ7.0A	SMBJ30A	

Note:
 Note: Output filtering capacitors C2, C4, C6 are electrolytic capacitors, it is recommended to use high frequency and low impedance electrolytic capacitor. For capacitance and current of capacitor please refer to manufacturer's datasheet. Capacitor withstand voltage derating should be 80% or above. C1, C3, C5 are ceramic capacitors, which is used to filter high-frequency noise, advice use 1μF. TVS is a recommended component to protect post-circuits if converter fails. External input MOV model is recommended to use S14K300.

2. EMC solution-recommended circuit

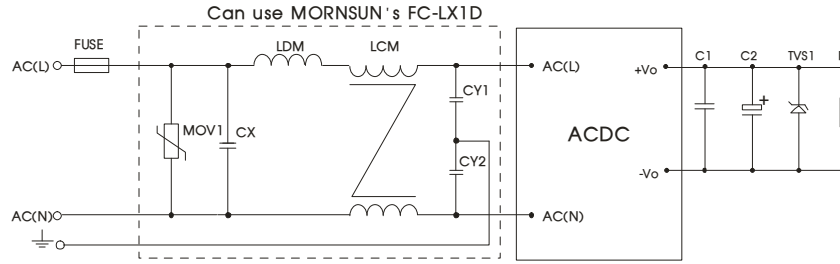
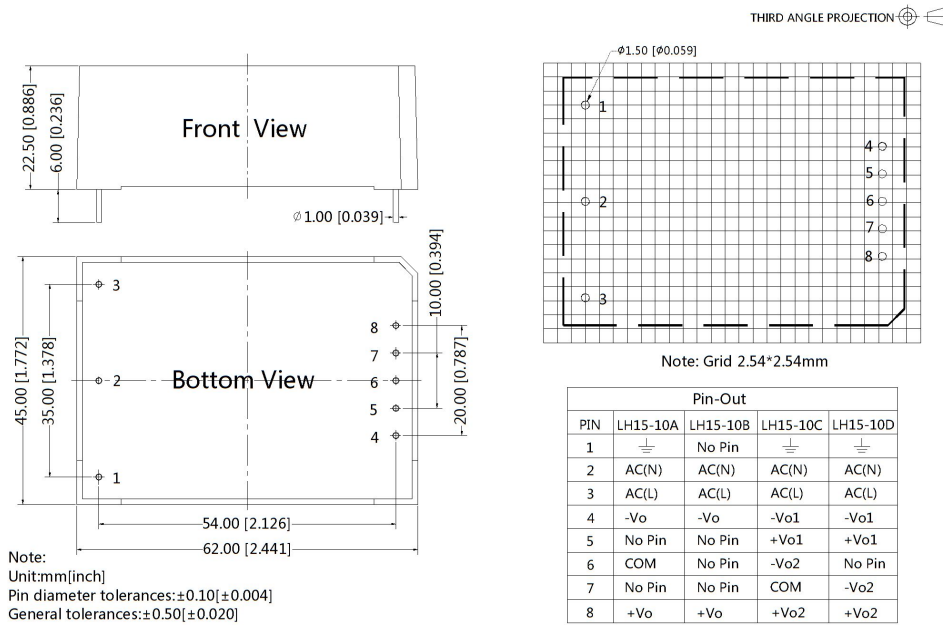

Fig 5: EMC Recommended circuit with higher requirements

Element model	Recommended value
MOV1	S14K300
CY1 , CY2	1000pF/400VAC
CX	0.1μF/275VAC
LCM	10mH, recommended to use MORNSUN's FL2D-Z5-103
LDM	4.7μH/2A
FC-LX1D	2KV/4KV EMC filter
FUSE	2A/250V slow fusing, necessary

3. For more information about Mornsun EMC Filter products, please visit www.mornsun-power.com to download the Selection Guide of EMC Filter



Dimensions and Recommended Layout

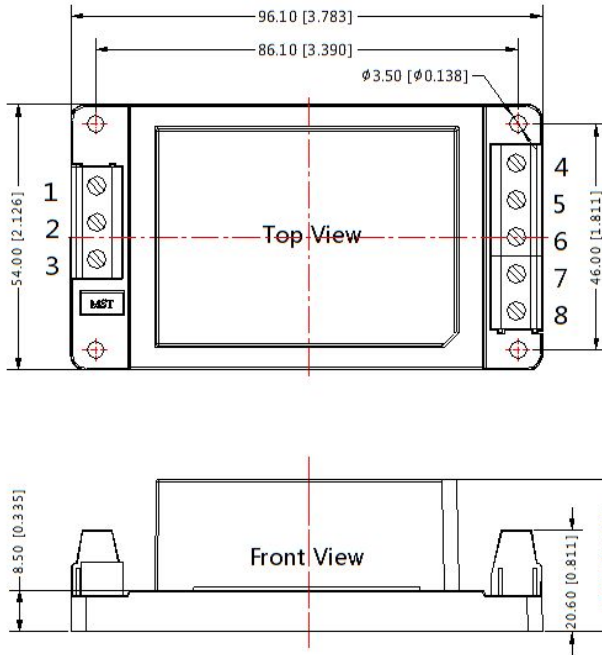

LHXXA2 Dimensions

THIRD ANGLE PROJECTION 







Pin	LH15-10A	LH15-10B	LH15-10C	LH15-10D
1		NC		
2	AC(N)	AC(N)	AC(N)	AC(N)
3	AC(L)	AC(L)	AC(L)	AC(L)
4	-Vo	-Vo	-Vo1	-Vo1
5	NC	NC	+Vo1	+Vo1
6	COM	NC	-Vo2	NC
7	NC	NC	COM	-Vo2
8	+Vo	+Vo	+Vo2	+Vo2

Note:
Unit:mm[inch]
Wire range : 24~12 AWG
General tolerances:±0.50[±0.020]

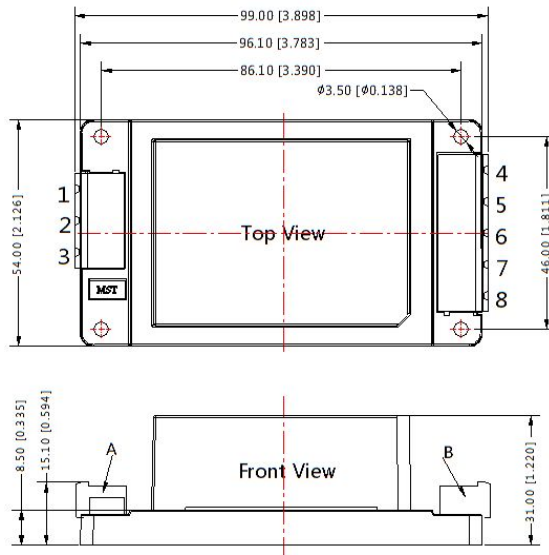
LHXXA3 Dimensions

THIRD ANGLE PROJECTION 







Pin	LH15-10A	LH15-10B	LH15-10C	LH15-10D
1		NC		
2	AC(N)	AC(N)	AC(N)	AC(N)
3	AC(L)	AC(L)	AC(L)	AC(L)
4	-Vo	-Vo	-Vo1	-Vo1
5	NC	NC	+Vo1	+Vo1
6	COM	NC	-Vo2	NC
7	NC	NC	COM	-Vo2
8	+Vo	+Vo	+Vo2	+Vo2

Note:
Unit:mm[inch]
General tolerances:±0.50[±0.020]
A:DEGSON P/N: 2EDGRC-7.5-03P-14-100A (H)
B: DEGSON P/N: 2EDGRC-7.5-05P-14-100A (H)

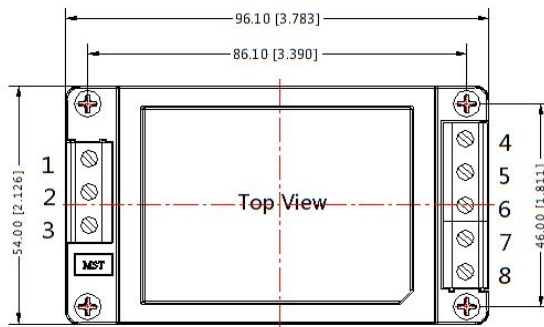
LHXXA4 Dimensions

THIRD ANGLE PROJECTION 



Pin	LH15-10A	LH15-10B	LH15-10C	LH15-10D
1		NC		
2	AC(N)	AC(N)	AC(N)	AC(N)
3	AC(L)	AC(L)	AC(L)	AC(L)
4	-Vo	-Vo	-Vo1	-Vo1
5	NC	NC	+Vo1	+Vo1
6	COM	NC	-Vo2	NC
7	NC	NC	COM	-Vo2
8	+Vo	+Vo	+Vo2	+Vo2

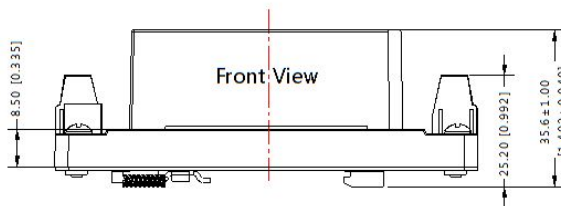

Note:
Unit:mm [inch]
Wire range : 24~12 AWG
Installed on DIN RAIL TS35
General tolerances:±0.50[±0.020]

Note:

1. Packing information please refer to Product Packing Information which can be downloaded from www.mornsun-power.com. Packing bag number of Horizontal package : 58220006, the Packing bag number of A2/A3/A4 package:58220010;
2. If the product is not operated within the required load range, the product performance cannot be guaranteed to comply with all parameters in the datasheet;
3. Unless otherwise specified, parameters in this datasheet were measured under the conditions of Ta=25 °C, humidity<75% with nominal input voltage and rated output load;
4. All index testing methods in this datasheet are based on our Company's corporate standards;
5. The performance parameters of the product models listed in this manual are as above, but some parameters of non-standard model products may exceed the requirements mentioned above. Please contact our technicians directly for specific information;
6. We can provide product customization service;
7. Specifications are subject to change without prior notice.

Mornsun Guangzhou Science & Technology Co., Ltd.

Address: No. 5, Kehui St. 1, Kehui Development Center, Science Ave., Guangzhou Science City, Luogang District, Guangzhou, P. R. China
Tel: 86-20-38601850-8801 Fax: 86-20-38601272 E-mail: info@mornsun.cn