

20(25)W, AC-DC converter



FEATURES

- Universal input:85~264VAC/100~370VDC
- Regulated output, low ripple & noise
- High efficiency up to 87%
- Output short circuit, over-current, over-voltage protection
- Plastic case, meets UL94V-0
- IEC60950, UL60950, EN60950 approval
- Mounting: PCB mounting, Chassis mounting, DIN-Rail mounting available

UL **CE** **CB** **RoHS**

LH 20-25 series —a compact size power converter offered by Mornsun. It features universal input voltage, taking both DC and AC input voltage, low power consumption, high efficiency, high reliability, safer isolation. It offers good EMC performance, which meet IEC/EN61000-4, CISPR22/EN55022, UL60950 and EN60950 standards, and it's widely used in industrial, office and civil applications. For harsh EMC environment, the application circuit in the datasheet is strongly recommended.

Selection Guide

Certification	Part No.*	Output Power	Nominal Output Voltage and Current		Efficiency (230VAC, %/Typ.)	Max. Capacitive Load(μF)	
			(Vo1/Io1)	(Vo2/Io2)		Vo1	Vo2
UL/CE/CB	LH20-10B03	13.53W	3.3V/4100mA	--	74	48000	--
	LH20-10B05	17.5W	5V/3500mA	--	78	12240	--
	LH20-10B09	20W	9V/2100mA	--	80	7200	--
	LH20-10B12		12V/1600mA	--	82	5400	--
	LH20-10B15		15V/1300mA	--	83	2720	--
	LH20-10B24		24V/850mA	--	85	1840	--
--	LH20-10A05	20W	+5V/2000mA	-5V/2000mA	75	8000	8000
	LH20-10A12		+12V/830mA	-12V/830mA	82	960	960
	LH20-10A15		+15V/650mA	-15V/650mA	83	880	880
	LH20-10C0505-05		5V/2500mA	±5V/500mA	74	11200	4480
	LH20-10C0512-04		5V/2000mA	±12V/400mA	75	16000	1600
	LH20-10C0515-03		5V/2000mA	±15V/300mA	76	13520	370
	LH20-10C0524-02		5V/2000mA	±24V/200mA	77	11200	370
	LH20-10D0512-06		5V/2500mA	12V/600mA	75	32400	3250
	LH20-10D0515-05		5V/2500mA	15V/500mA	76	28000	1980
	LH20-10D0524-03		5V/2500mA	24V/300mA	77	28000	720
UL/CE/CB	LH25-10B03	13.53W	3.3V/4100mA	--	74	48000	--
	LH25-10B05	20.5W	5V/4100mA	--	79	12240	--
	LH25-10B09	25W	9V/2500mA	--	81	5600	--
	LH25-10B12		12V/2100mA	--	83	5400	--
	LH25-10B15		15V/1600mA	--	84	2400	--
	LH25-10B24		24V/1100mA	--	85	1440	--
	LH25-10B48		48V/500mA	--	87	500	--

Note: *About LH20-10AXX, use both positive and negative output as sampling feedback; and all others use Vo1 as sampling feedback.

Input Specifications

Item	Operating Conditions	Min.	Typ.	Max.	Unit
Input Voltage Range	AC input	85	--	264	VAC
	DC input	100	--	370	VDC
Input frequency		47	--	63	Hz
Input current	115VAC	--	--	0.6	A
	230VAC	--	--	0.34	
Inrush current	115VAC	--	16	--	
	230VAC	--	30	--	
Leakage current		0.3mA RMS typ./230VAC/50Hz			
Recommended External Input Fuse(Special package series include fuse)		3.15A/250V, slow fusing			
Hot Plug		Unavailable			

Output Specifications

Item	Operating Conditions	Min.	Typ.	Max.	Unit	
Output Voltage	Main circuit	--	±2	--		
Line Regulation	Full load	Main circuit	±0.5	--		
		Auxiliary circuit	±1.5	--		
Load Regulation	0%-100% load	Single output	±1	--		%
		Dual output(balanced load)	±2	--		
	10%-100% load	Isolated triple output (balanced load)	Main circuit	±3	--	
			Auxiliary circuit	±5	--	
		Isolated and separated twin output (balanced load)	Main circuit	±3	--	
Auxiliary circuit	±5	--				
Ripple & Noise*	Main circuit	20MHz bandwidth (peak-peak value)	--	50	100	mV
Temperature Coefficient	Main circuit	--	±0.02	--	%/°C	
Short Circuit Protection		Continuous, self-recovery				
Over-current Protection		≥110%Io self-recovery				
Over-voltage Protection	Main circuit	3.3 / 5VDC Output	≤7.5VDC			
		9VDC Output	≤13VDC			
		12 / 15VDC Output	≤20VDC			
		24VDC Output	≤30VDC			
		48VDC Output	≤60VDC			
Min. Load	Single output models		0	--	--	%
	Dual output models (balanced load)		10	--	--	
	Isolated and separated twin output (balanced load)		10	--	--	
	Isolated triple output (balanced load)		10	--	--	
Hold-up Time	115VAC input		--	15	--	ms
	230VAC input		--	80	--	

Note: * Ripple and noise are measured by "parallel cable" method, please see AC-DC Converter Application Notes for specific operation.

General Specifications

Item	Operating Conditions	Min.	Typ.	Max.	Unit
Isolation Voltage	Input-output	3000	--	--	VAC
	Input- 	2000	--	--	
Operating Temperature		-40	--	+70	°C
Storage Temperature		-40	--	+85	
Storage Humidity		--	--	95	%RH
Welding Temperature	Wave-soldering	260±5°C; time:5~10s			
	Manual-welding	360±10°C; time:3~5s			

Switching Frequency		--	65	--	kHz
Power Derating	-40°C~-10°C	2.0	--	--	% / °C
	+50°C~+70°C (LH25-10B Series)	3.0	--	--	
	+55°C~+70°C (LH20-10A/B/C/D Series)	4.0	--	--	
Safety Standard					IEC60950/EN60950/UL60950
Safety Certification					IEC60950/EN60950/UL60950
Safety Class					CLASS I
MTBF	MIL-HDBK-217F@25°C > 300,000 h				

Physical Specifications

Casing Material	Black flame-retardant and heat-resistant plastic (UL94-V0)				
Dimension	Horizontal packageg	70.00x48.00x23.50mm			
	A2 chassis mounting	96.10x54.00x32.00mm			
	A3 chassis mounting	99.00x54.00x32.00mm			
	A4 Din-Rail mountin	96.10x54.00x36.60mm			
Weight	Horizontal package/A2 chassis mounting/ A3 chassis mounting/A4 Din-Rail mounting	120g/170g /170g /210g (Typ.)			
Cooling method	Free convection				

EMC Specifications

EMI	CE	CISPR22/EN55022, CLASS B			
	RE	CISPR22/EN55022, CLASS B			
EMS	ESD	IEC/EN61000-4-2	±6KV/±8KV	Perf. Criteria B	
	RS	IEC/EN61000-4-3	10V/m	perf. Criteria A	
	EFT	IEC/EN61000-4-4	±2KV	perf. Criteria B	
		IEC/EN61000-4-4	±4KV (See Fig. 5 for recommended circuit)	perf. Criteria B	
	Surge	IEC/EN61000-4-5	±1KV/±2KV	perf. Criteria B	
IEC/EN61000-4-5		±2KV/4KV (See Fig. 5 for recommended circuit)	perf. Criteria B		
EMS	CS	IEC/EN61000-4-6	10 Vr.m.s	perf. Criteria A	
	PFM	IEC/EN61000-4-8	10A/m	perf. Criteria A	
	Immunities of voltage dip, drop and short interruption	IEC/EN61000-4-11	0%-70%	perf. Criteria B	

Product Characteristic Curve

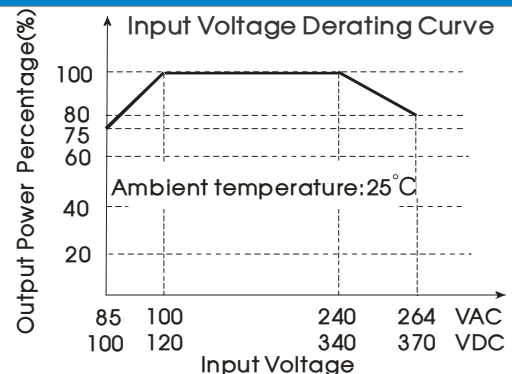
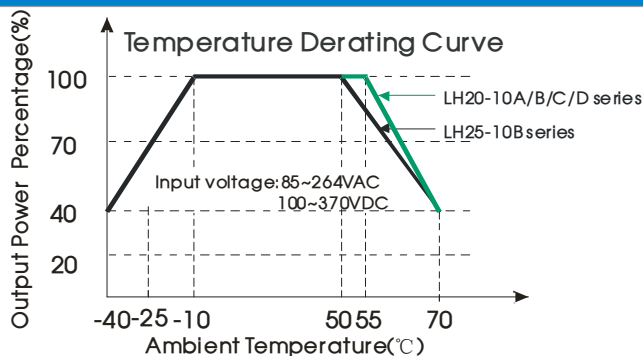

Note: ①When input 85~100VAC/240~264VAC/100~120VDC/340~370VDC, it need to be voltage derated on basis of temperature derating;
②This product is suitable for use in natural air cooling environments, if in a closed environment, please contact our company's FAE.

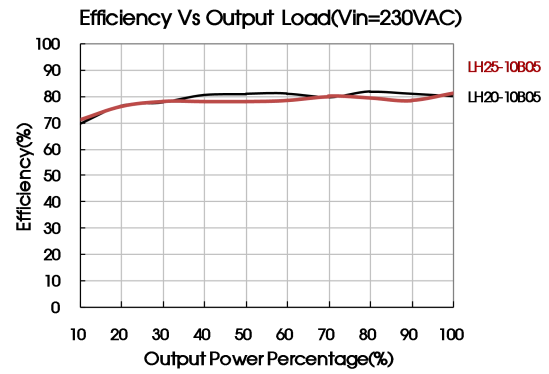
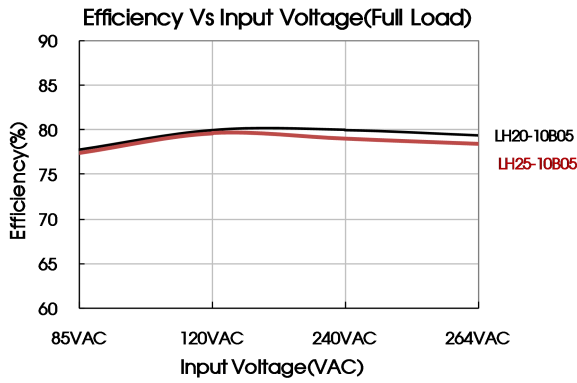

Design Reference

1. Typical application circuit

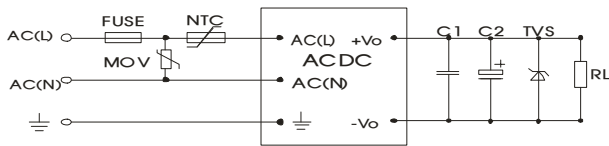

Fig. 1: LH20(25)-10B series (Single Output) typical application circuit

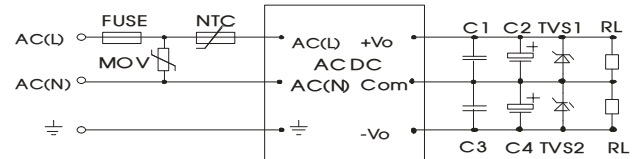

Fig. 2: LH20-10A series (Dual Output) typical application circuit

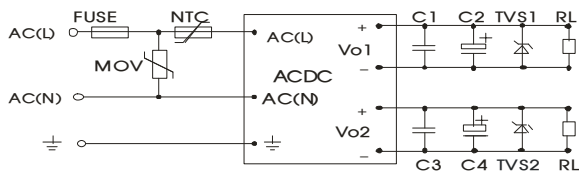

Fig. 3: LH20-10D series (Isolate Twin Output) typical application circuit

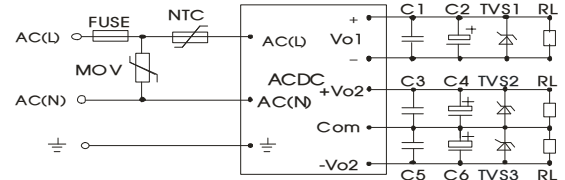

Fig. 4: LH20-10C series (Triple Output) typical application circuit

Model	C2(μ F)	C4(μ F)	C6(μ F)	TVS1	TVS2	TVS3
LH20-10B03	330	--	--	SMBJ7.0A	--	--
LH20-10B05	330	--	--	SMBJ7.0A	--	--
LH20-10B09	220	--	--	SMBJ12A	--	--
LH20-10B12	220	--	--	SMBJ20A	--	--
LH20-10B15	220	--	--	SMBJ20A	--	--
LH20-10B24	220	--	--	SMBJ30A	--	--
LH20-10A05	470	470	--	SMBJ7.0A	SMBJ7.0A	--
LH20-10A12	120	120	--	SMBJ20A	SMBJ20A	--
LH20-10A15	68	68	--	SMBJ20A	SMBJ20A	--
LH20-10C0505-05	330	120	120	SMBJ7.0A	SMBJ7.0A	SMBJ7.0A
LH20-10C0512-04	330	120	120	SMBJ7.0A	SMBJ20A	SMBJ20A
LH20-10C0515-03	330	120	120	SMBJ7.0A	SMBJ20A	SMBJ20A
LH20-10C0524-02	330	47	47	SMBJ7.0A	SMBJ30A	SMBJ30A
LH20-10D0512-06	330	220	--	SMBJ7.0A	SMBJ20A	--
LH20-10D0515-05	330	220	--	SMBJ7.0A	SMBJ20A	--
LH20-10D0524-03	330	120	--	SMBJ7.0A	SMBJ30A	--
LH25-10B03	330	--	--	SMBJ7.0A	--	--
LH25-10B05	330	--	--	SMBJ7.0A	--	--
LH25-10B09	330	--	--	SMBJ12A	--	--
LH25-10B12	330	--	--	SMBJ20A	--	--
LH25-10B15	330	--	--	SMBJ20A	--	--
LH25-10B24	120	--	--	SMBJ30A	--	--
LH25-10B48	68	--	--	SMBJ64A	--	--

Note:
 Note: Output filtering capacitors C2, C4, C6 are electrolytic capacitors, It is recommended to use high frequency and low impedance electrolytic capacitor. For capacitance and current of capacitor please refer to manufacture's datasheet. Capacitor withstand voltage derating should be 80% or above. C1, C3, C5 are ceramic capacitors, which is used to filter high-frequency noise. TVS is a recommended component to protect post-circuits if converter fails. External input NTC is recommended to use 5D-9. External input MOV model is recommended to use S14K300.

2. EMC solution-recommended circuit

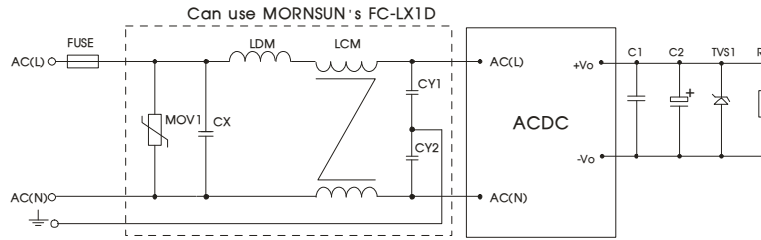
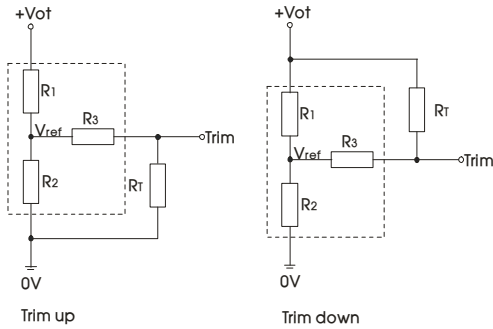

Fig 5: EMC Recommended circuit with higher requirements

Element model	Recommended value
MOV1	S14K300
CY1 , CY2	1000pF/400VAC
CX	0.1μF/275VAC
LCM	10mH, recommended to use MORNSUN's FL2D-Z5-103
LDM	4.7μH/2A
FC-LX1D	2KV/4KV EMC filter
FUSE(Required)	3.15A/250V slow fusing, necessary

3. Application of Trim and calculation of Trim resistance



Calculation formula of Trim resistance:

$$\text{up: } R_T = \frac{\alpha R_2}{R_2 - \alpha} - R_3 \quad \alpha = \frac{V_{ref}}{V_{ot} - V_{ref}} \cdot R_1$$

$$\text{down: } R_T = \frac{\alpha R_1}{R_1 - \alpha} - R_3 \quad \alpha = \frac{V_{ot} - V_{ref}}{V_{ref}} \cdot R_2$$

R_T is Trim resistance
 α is a self-defined parameter, with no real meaning.

Applied circuits of Trim (Part in broken line is the interior of models):

Vout	R1(KΩ)	R2(KΩ)	R3(KΩ)	Vref(V)	Vot(V)
3.3V	3.3	1.98	1	1.24	Output voltage after regulation, variation $\leq \pm 10\%$
5V	3.3	3.3	1	2.5	
9V	7.5	2.87	1	2.5	
12V	3.83	1	1	2.5	
15V	7.5	1.5	1	2.5	
24V	8.66	1	1	2.5	
48V	68	3.73	1	2.5	

4. For more information about Mornsun EMC Filter products, please visit www.mornsun-power.com to download the Selection Guide of EMC Filter

Dimensions and Recommended Layout

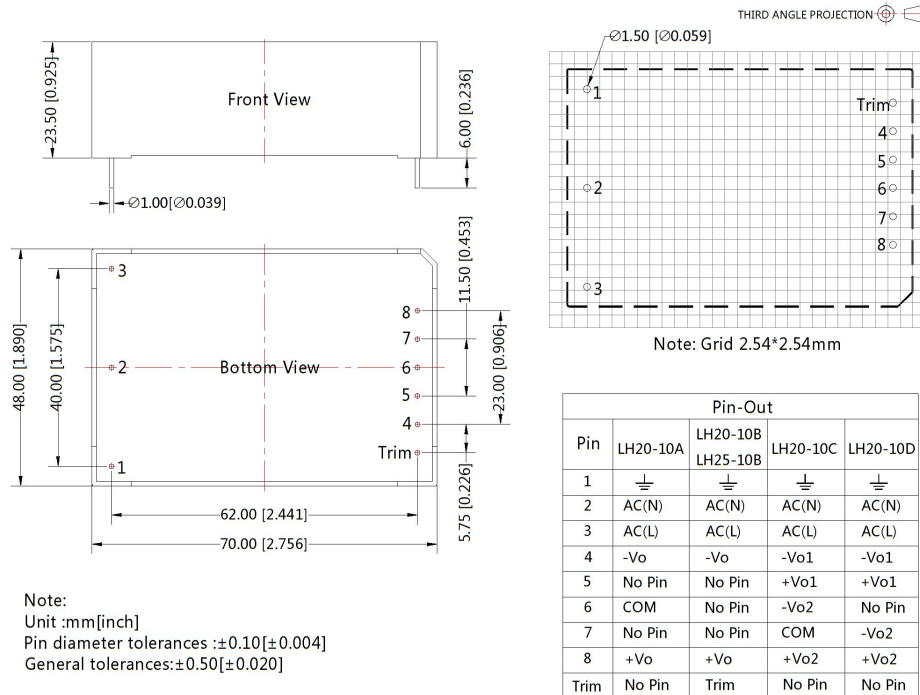

LHXXA2 Dimensions

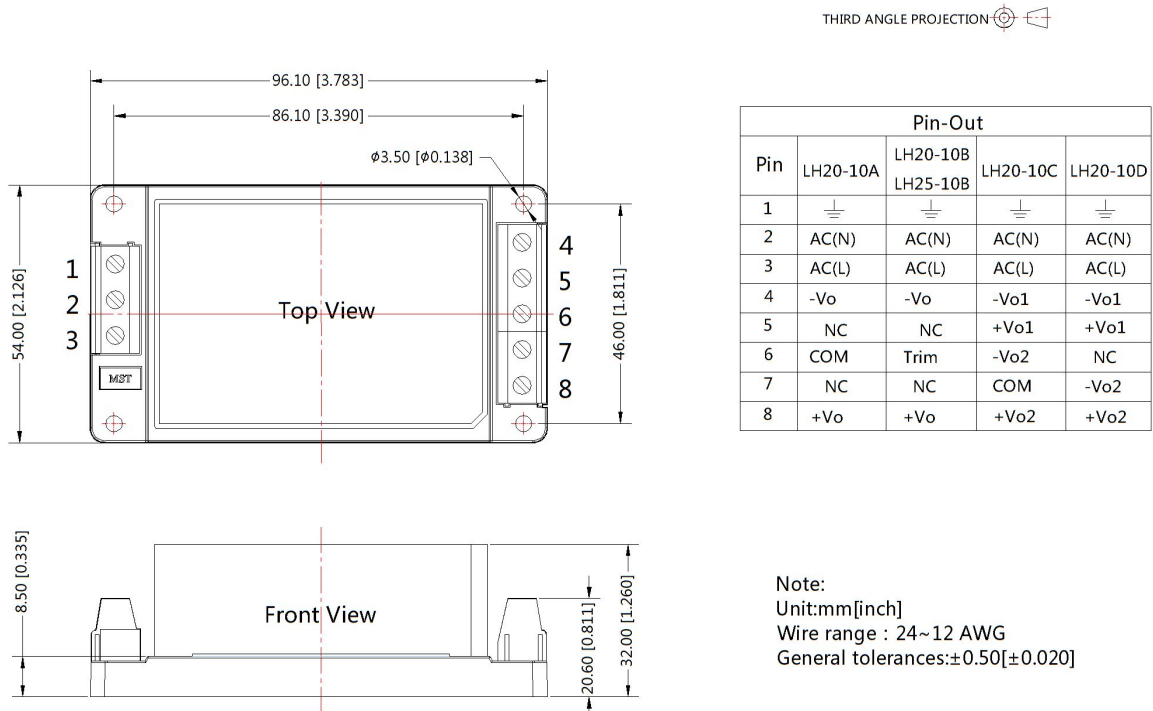

LHXXA3 Dimensions

THIRD ANGLE PROJECTION

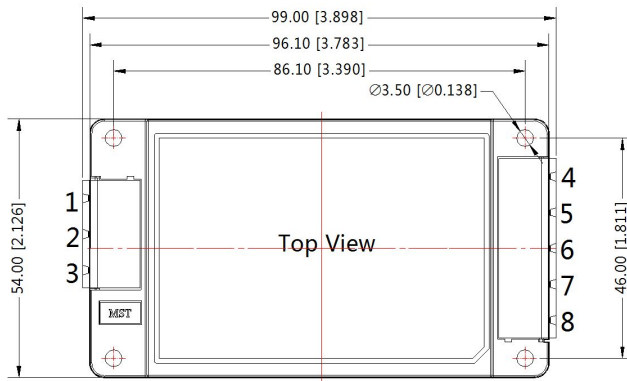

Pin-Out				
Pin	LH20-10A	LH20-10B LH25-10B	LH20-10C	LH20-10D
1	⏏	⏏	⏏	⏏
2	AC(N)	AC(N)	AC(N)	AC(N)
3	AC(L)	AC(L)	AC(L)	AC(L)
4	-Vo	-Vo	-Vo1	-Vo1
5	NC	NC	+Vo1	+Vo1
6	COM	Trim	-Vo2	NC
7	NC	NC	COM	-Vo2
8	+Vo	+Vo	+Vo2	+Vo2

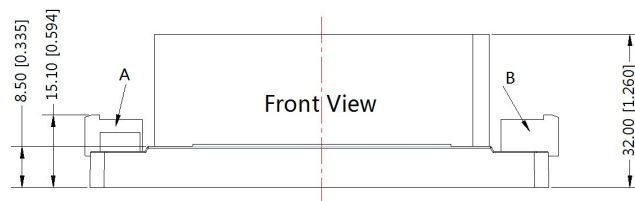

Note:
Unit:mm[inch]
General tolerances:±0.50[±0.020]
A:DEGSON P/N:
2EDGRC-7.5-03P-14-100A (H)
B:DEGSON P/N:
2EDGRC-7.5-05P-14-100A (H)

LHXXA4 Dimensions

THIRD ANGLE PROJECTION

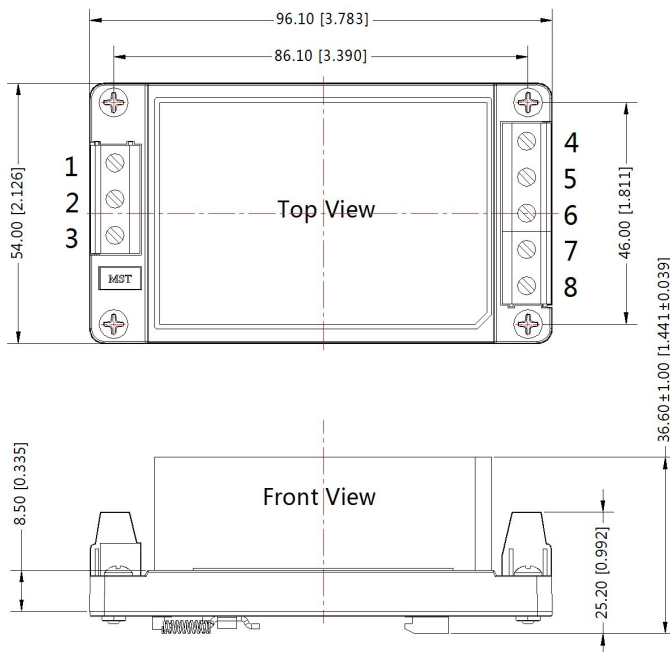

Pin-Out				
Pin	LH20-10A	LH20-10B LH25-10B	LH20-10C	LH20-10D
1	⏏	⏏	⏏	⏏
2	AC(N)	AC(N)	AC(N)	AC(N)
3	AC(L)	AC(L)	AC(L)	AC(L)
4	-Vo	-Vo	-Vo1	-Vo1
5	NC	NC	+Vo1	+Vo1
6	COM	Trim	-Vo2	NC
7	NC	NC	COM	-Vo2
8	+Vo	+Vo	+Vo2	+Vo2

Note:
Unit:mm[inch]
Installed on DIN rail TS35
Wire range : 24~12 AWG
General tolerances:±0.50[±0.020]

Notes:

1. Packing information please refer to Product Packing Information which can be downloaded from www.mornsun-power.com. Packing bag number of Horizontal package : 58220006, the Packing bag number of A2/A3/A4 package:58220010;
2. If the product is not operated within the required load range, the product performance cannot be guaranteed to comply with all parameters in the datasheet;
3. Unless otherwise specified, parameters in this datasheet were measured under the conditions of $T_a=25\text{ }^\circ\text{C}$, humidity<75% with nominal input voltage and rated output load;
4. All index testing methods in this datasheet are based on our Company's corporate standards;
5. The performance parameters of the product models listed in this manual are as above, but some parameters of non-standard model products may exceed the requirements mentioned above. Please contact our technicians directly for specific information;
6. We can provide product customization service;
7. Specifications are subject to change without prior notice.

MORNSUN Guangzhou Science & Technology Co., Ltd.

Address: No. 5, Kehui St. 1, Kehui Development Center, Science Ave., Guangzhou Science City, Luogang District, Guangzhou, P. R. China
Tel: 86-20-38601850-8801 Fax: 86-20-38601272 E-mail: info@mornsun.cn