

DC-DC module power supply specialized for SiC driver

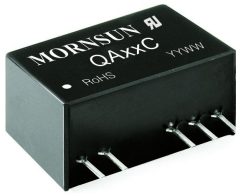

Continuous Short
Circuit Protection



Patent Protection RoHS

FEATURES

- Efficiency up to 83%
- SIP package
- Isolation voltage : 3.5KVAC/6KVDC
- Ultra low-volume isolation capacitance
- Operating temperature range: -40°C ~ +105°C
- Continuous short circuit protection
- International standard pin-out
- UL60950, EN60950 and IEC60950 Approval

QA01C is DC-DC module power supply designed for SiC driver requiring two set of isolation power supply. The mode of mutual connection after two independent outputs is adopted internally for better energy provision of SiC turn-on and turn-off. Output short circuit protection and self-recovery capabilities are also provided. General application includes:

- 1) Universal converter
- 2) AC servo drive system
- 3) Electric welding machine
- 4) Uninterruptible power supply (UPS)

Selection Guide

Certification	Part No.	Input Voltage (VDC)	Output		Efficiency (%Min./Typ.) @ Full Load	Max. Capacitive Load* (µF)
		Nominal (Range)	Output Voltage (VDC)+Vo/-Vo	Output Current (mA)+Io/-Io		
UL/CE/CB	QA01C	15 (13.5-16.5)	+20/-4	+100/-100	79/83	220

Note:*The capacitive loads of positive and negative outputs are identical.

Input Specifications

Item	Operating Conditions	Min.	Typ.	Max.	Unit
Input Current (full load / no-load)	15V input	--	193/16	--	mA
Surge Voltage (1sec. max.)		-0.7	--	21	VDC
Input Filter		Capacitor filter			
Hot Plug		Unavailable			

Output Specifications

Item	Operating Conditions	Min.	Typ.	Max.	Unit	
Output Voltage Accuracy		See tolerance envelope graph (Fig. 1, Fig. 2)				
Line Regulation	Input voltage change: ±10%	--	±1.1	±1.3	%/%	
Load Regulation	10%-100% load	20VDC output	--	5	8	%
		-4VDC output	--	10	15	
Ripple & Noise*	20MHz bandwidth	Ripple	--	60	--	mVp-p
		Noise	--	75	--	
Temperature Coefficient	Full load	--	--	±0.03	%/°C	
Short Circuit Protection		Continuous, self-recovery				

Note:* Ripple and noise are measured by "parallel cable" method, please see DC-DC Converter Application Notes for specific operation.

General Specifications

Item	Operating Conditions	Min.	Typ.	Max.	Unit
Isolation Voltage	Input-output, with the test time of 1 minute and the leak current lower than 1mA	3500	--	--	VAC
		6000	--	--	VDC
Isolation Resistance	Input-output, Isolation voltage 500VDC	1000	--	--	MΩ
Isolation Capacitance	Input-output, 100KHz/0.1V	--	3.5	--	pF
Operating Temperature*		-40	--	105	°C

Storage Temperature		-55	--	125	°C
Pin Welding Resistance Temperature	Welding spot is 1.5mm away from the casing, 10 seconds	--	--	300	
Casing Temperature Rise	Ta=25°C	--	30	--	
Storage humidity	Non-condensing	--	--	95	%RH
Switching frequency	100% load, nominal input voltage	--	95	--	KHz
MTBF	MIL-HDFK-217F@25°C	3500	--	--	K hours

Note: * 1. Power derating $\geq 85^{\circ}\text{C}$, (see Fig. 3);
2. The product's max certification operating temperature: 85°C .

Physical Specifications

Casing Material	Black flame-retardant and heat-resistant plastic (UL94-V0)
Dimensions	19.50*9.80*12.50mm
Weight	4.2g (Typ.)
Cooling Method	Free convection

EMC Specifications

EMI	CE	CISPR22/EN55022 CLASS B (see Fig. 5 for recommended circuit)
	RE	CISPR22/EN55022 CLASS B (see Fig. 5 for recommended circuit)
EMS	ESD	IEC/EN61000-4-2 Contact $\pm 6\text{KV}$ perf. Criteria B

Product Characteristic Curve

Positive Output Voltage Tolerance Envelope Graph

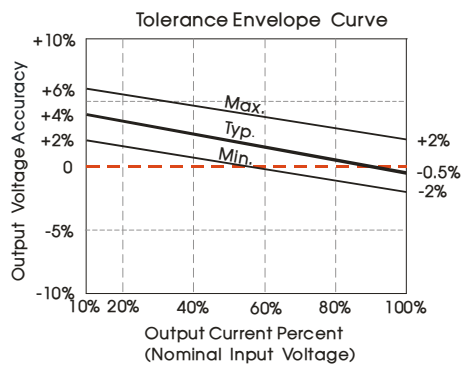

Fig. 1

Negative Output Voltage Tolerance Envelope Graph

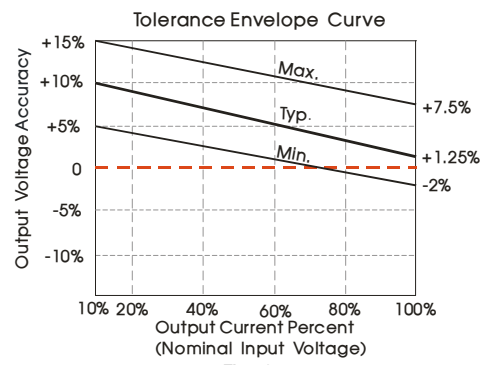

Fig. 2

Temperature Derating Curve

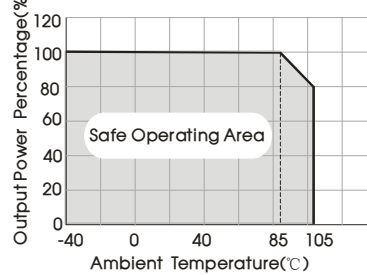
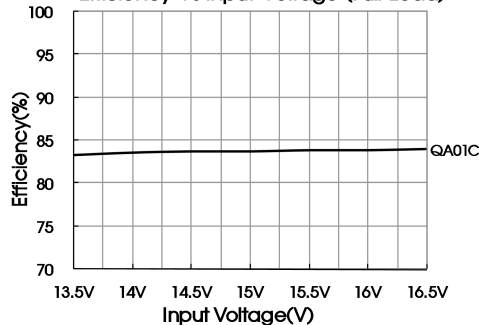
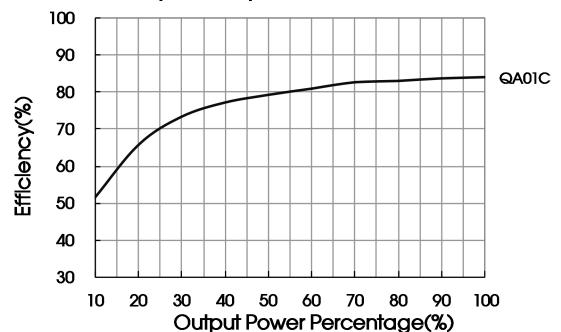

Fig. 3

Efficiency Vs Input Voltage (Full Load)



Efficiency Vs Output Load (Vin=Vin-nominal)



Design Reference

1. Overload Protection

In normal operating conditions, the circuit of these products have no overload protection. Protect with a breaker is a simple way to make overload protection.

2. Test configurations

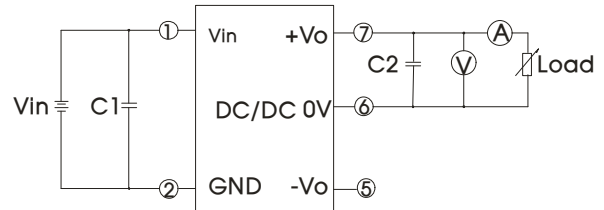
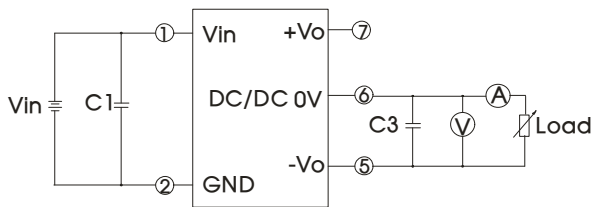

Note: C1,C2,C3: 100uF/35V (Low impedance)

3. Typical application

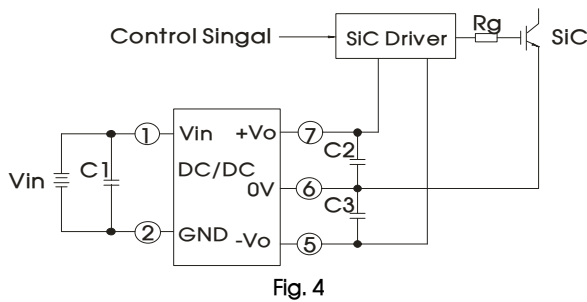

Fig. 4

C1/C2/C3
100uF/35V (Low internal resistance capacitance)

4. EMC typical recommended circuit (CLASS B)

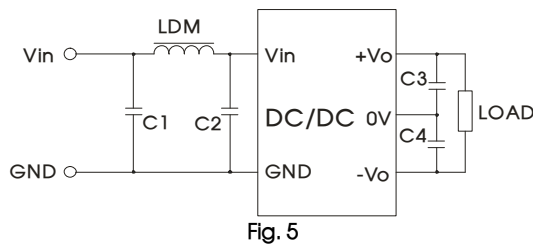

Fig. 5

Input voltage (VDC)		15
EMI	C1/C2	4.7μF /50V
	C3/C4	100μF /35V (Low internal resistance capacitance)
	LDM	6.8μH

- It is not allowed to connect modules output in parallel to enlarge the power
- The input and the output of the product are recommended to be connected to ceramic capacitor or electrolytic capacitor. Using tantalum capacitor may cause risk of failure
- For more information please find DC-DC converter application notes on www.mornsun-power.com

Dimensions and Recommended Layout

THIRD ANGLE PROJECTION ☺ ◀

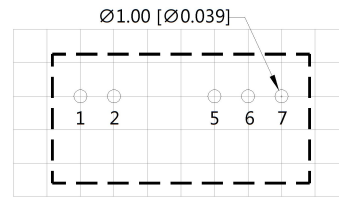
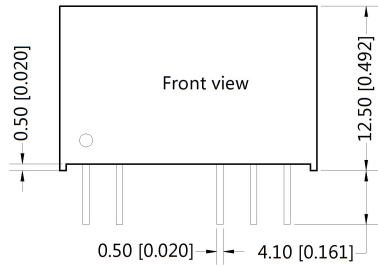

Note: Grid 2.54*2.54mm

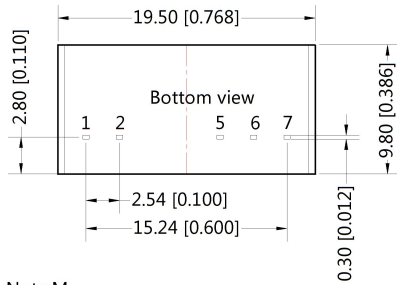

Pin-Out	
Pin	Function
1	Vin
2	GND
5	-Vo
6	0V
7	+Vo

Note:M
Unit :mm[inch]
Pin section tolerances:±0.10[±0.004]
General tolerances:±0.25[±0.010]

Notes:

1. Packing information please refer to Product Packing Information which can be downloaded from www.mornsun-power.com. Packing bag number: 58200013;
2. The lead connecting the power supply module and SiC driver should be as short as possible during use;
3. The output filtering capacitor should be as close as possible to the power supply module and SiC driver;
4. The peak of the SiC driver gate drive current is high, so low internal resistance electrolytic capacitor is recommended to be used for the power supply module output filter capacitor;
5. The average output power of the driver must be lower than that of the power supply module;
6. Consider fixing with glue near the module if being used in vibration occasion;
7. The max. capacitive load should be tested within the input voltage range and under full load conditions;
8. Unless otherwise specified, data in this datasheet should be tested under the conditions of Ta=25°C, humidity<75% when inputting nominal voltage and outputting rated load;
9. All index testing methods in this datasheet are based on our Company's corporate standards;
10. The performance indexes of the product models listed in this manual are as above, please directly contact our technicians for specific information;
11. We can provide product customization service;
12. Specifications are subject to change without prior notice.

MORNSUN Guangzhou Science & Technology Co., Ltd.

Address: No. 5, Kehui St. 1, Kehui Development Center, Science Ave., Guangzhou Science City, Luogang District, Guangzhou, P. R. China
Tel: 86-20-38601850-8801 Fax: 86-20-38601272 E-mail: info@mornsun.cn