

MORNSUN®

WRA_S - 1WR2 & WRB_S-1WR2 Series 1W, WIDE INPUT, ISOLATED & REGULATED DUAL/SINGLE OUTPUT DC-DC CONVERTER

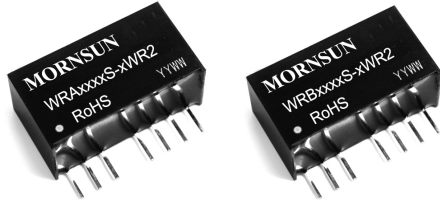

Patent Protected RoHS

PART NUMBER SYSTEM

WRB2405S-1WR2

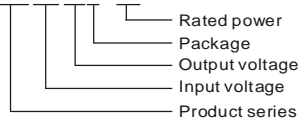

FEATURES

- Miniature SIP Package
- 2:1 wide input voltage range
- Temperature range: -40°C ~ +85°C
- 1.5KVDC isolation
- Short Circuit Protection(automatic recovery)
- Remote On/Off

APPLICATION

The WRA_S-1WR2 & WRB_S-1WR2 Series are specially designed for applications where a wide range input voltage power supplies are isolated from the input power supply in a distributed power supply system on a circuit board. For these DC-DC converters, you can reduce the failure points of design, and save the manpower, material and time cost in developing micro power supply, and also ensure better quality, stability, safety protection, and reliability for the end products.

These products apply to where:

- 1) Input voltage range $\leq 2:1$;
- 2) Input and output isolation $\leq 1.5KVDC$;
- 3) Regulated and low ripple noise is required.

Such as: industrial control, tele-communications etc.

SELECTION GUIDE

Model	Input Voltage(VDC)		Output Voltage (VDC)	Output Current (mA)		Input Current (mA)(Typ.)		Reflected Ripple Current (mA, Typ.)	Max. Capacitive Load ^② (μF)	Efficiency (% Typ.) @Max. Load
	Nominal (Range)	Max. ①		Max.	Min.	@Max. Load	@No Load			
WRA0505S-1WR2	5 (4.5-9)	11	±5	±100	±5	274	25	30	1000	73
WRA0512S-1WR2			±12	±42	±2	263				76
WRA0515S-1WR2			±15	±33	±2	267				75
WRB0505S-1WR2			5	200	10	278				72
WRB0512S-1WR2			12	83	4	263				76
WRB0515S-1WR2			15	67	3	267				75
WRA1205S-1WR2	12 (9-18)	20	±5	±100	±5	107	12	40	1000	78
WRA1212S-1WR2			±12	±42	±2	103				81
WRA1215S-1WR2			±15	±33	±2	104				80
WRB1203S-1WR2			3.3	303	15	112				75
WRB1205S-1WR2			5	200	10	108				77
WRB1209S-1WR2			9	111	6	106				79
WRB1212S-1WR2			12	83	4	104				80
WRB1215S-1WR2			15	67	3	104				80
WRA2405S-1WR2	24 (18-36)	40	±5	±100	±5	52	6	55	1000	80
WRA2412S-1WR2			±12	±42	±2	52				80
WRA2415S-1WR2			±15	±33	±2	52				80
WRB2403S-1WR2			3.3	303	15	56				75
WRB2405S-1WR2			5	200	10	54				77
WRB2412S-1WR2			12	83	4	51				81
WRB2415S-1WR2			15	67	3	53				79
WRB2424S-1WR2			24	42	2	54				77
WRA4805S-1WR2	48 (36-75)	80	±5	±100	±5	27	4	70	1000	76
WRA4812S-1WR2			±12	±42	±2	26				80
WRA4815S-1WR2			±15	±33	±2	26				80
WRB4803S-1WR2			3.3	303	15	28				75
WRB4805S-1WR2			5	200	10	27				76

WRB4812S-1WR2		12	83	4	26		1000	81
WRB4815S-1WR2		15	67	3	26		680	80

Note: ①. Absolute maximum rating without damage on the converter, but it isn't recommended.
 ②. For dual output converter, the given value is the same for each output.

INPUT SPECIFICATIONS

Item	Test Conditions	Min.	Typ.	Max.	Unit
Input Surge Voltage (1sec. max.)	5V input	-0.7	--	12	
	12V input	-0.7	--	25	
	24V input	-0.7	--	50	
	48V input	-0.7	--	100	
Start-up Voltage	5V input	3.5	4	4.5	
	12V input	4.5	8	9	
	24V input	11	16	18	
	48V input	24	33	36	
Input Filter		C Filter			
Ctrl*	Models ON	Ctrl open or be insulated			
	Models OFF	Connect higher level of voltage to make sure that the input current flow into Ctrl is 5-10mA.			

Note: *Please refer to "DESIGN CONSIDERATIONS" as the direction for use of Ctrl.

OUTPUT SPECIFICATIONS

Item	Test Conditions	Min.	Typ.	Max.	Unit
Output Voltage Accuracy	5% to 100% load	--	±1	±3	%
No-load Output Voltage Accuracy	Input voltage range	--	±1.5	±5	
Output Voltage Balance	Dual output, balanced loads	--	±0.3	±0.5	
Line Regulation	Full load, Input voltage from low to high	--	±0.2	±0.5	
Load Regulation	5% to 100% load	--	±0.4	±0.75	
Transient Recovery Time	25% load step change	--	0.5	2	ms
Transient Response Deviation		--	±2.5	±5	%
Temperature coefficient	100% load	--	±0.02	±0.03	%/°C
Ripple *	20MHz Bandwidth	--	30	50	mVp-p
Noise*		--	55	75	
Output Short Circuit Protection		Continuous, automatic recovery			

Note: *Ripple and noise are tested with "parallel cable" method. See detailed operation instructions at DC-DC Application Notes.

COMMON SPECIFICATIONS

Item	Test Conditions	Min.	Typ.	Max.	Unit
Isolation Voltage	Input-Output, Tested for 1 minute, leakage current less than 1 mA	1500	--	--	VDC
Isolation Resistance	Input-Output, Test at 500VDC	1000	--	--	MΩ
Isolation Capacitance	Input-Output, 100KHz/0.1V	--	120	--	pF
Switching Frequency(PFM Mode)	100% load, Nominal Input voltage	--	200	--	KHz
MTBF	MIL-HDBK-217F @25°C	1000	--	--	K hours
Case Material		Plastic (UL94-V0)			
Weight		--	4.9	--	g

ENVIRONMENTAL SPECIFICATIONS

Item	Test Conditions	Min.	Typ.	Max.	Unit
Storage Humidity	Non condensing	--	--	95	%
Operating Temperature	Power derating (above85°C, see Figure 5)	-40	--	85	°C
Storage Temperature		-55	--	125	
Case Temperature Rise	Ta=25°C	--	25	--	
Lead Temperature	1.5mm from case for 10 seconds	--	--	300	
Cooling		Free air convection			

EMC SPECIFICATIONS

EMI	CE	CISPR22/EN55022 CLASS B (Recommended Circuit Refer to Figure1-② or Figure 3)
	RE	CISPR22/EN55022 CLASS B (Recommended Refer to Figure1-② or Figure 3)

The copyright and authority for the interpretation of the products are reserved by MORNSUN

EMS	ESD	IEC/EN61000-4-2	Contact ±4KV	perf. Criteria B
	RS	IEC/EN61000-4-3	10V/m	perf. Criteria A
	EFT	IEC/EN61000-4-4	±2KV (Recommended Circuit Refer to Figure1-①)	perf. Criteria B
		IEC/EN61000-4-4	±4KV (Recommended Circuit Refer to Figure 3)	perf. Criteria B
	Surge	IEC/EN61000-4-5	±2KV (Recommended Circuit Refer to Figure1-① or Figure 3)	perf. Criteria B
	CS	IEC/EN61000-4-6	3 Vr.m.s	perf. Criteria A
	Voltage dips, short and interruptions immunity	IEC/EN61000-4-29	0%-70%	perf. Criteria B

EMC RECOMMENDED CIRCUIT

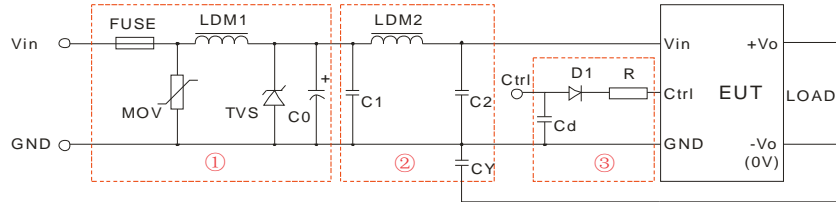

(Figure1)

Recommended external circuit parameters:

Model	Vin:5V	Vin:12V	Vin:24V	Vin:48V
FUSE	Slow blow ,choose according to practical input current			
MOV	--	--	S14K35	S14K60
LDM1	--	--	56μH	56μH
TVS	SMCJ13A	SMCJ28A	SMCJ48A	SMCJ90A
C0	680μF/16V	680μF/25V	330μF/50V	330μF/100V
C1	4.7μF/50V		4.7μF/100V	
LDM2	12μH			
C2	4.7μF/50V		4.7μF/100V	
CY	1nF/2KV			
D1	RB160M-60/1A			
R	Follows: $R = \frac{V_C - V_D - 1.0}{I_C} - 300$			
Cd	47nF/100V			

Note: 1. In Figure 1, part ① is the recommended external circuit for EMS , and part ② is for EMI .Choose according to requirements.

2. VC is between Ctrl and GND, VD is the forward conduction voltage drop of D1, IC is the current through Ctrl pin which is normally 5-10mA, the external circuit of Ctrl is as shown in figure1-③.

3. If there is no recommended parameters, no external component is required.

EMC RECOMMENDED CIRCUIT PCB LAYOUT

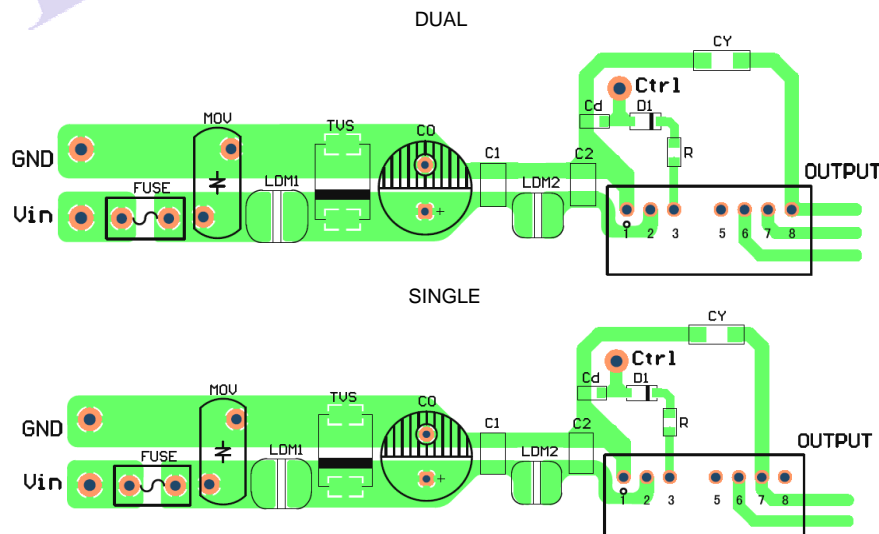

(Figure 2)

Note: The pad space between input and output GND (CY) must be ≥2mm.

EMC MODULE APPLICATION CIRCUIT

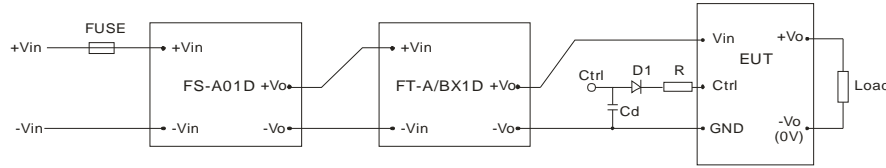

FS-A01D, FT-A/BX1D are MORNSUN's EFT suppresser
(Figure 3)

EMC MODULE RECOMMENDED CIRCUIT PCB LAYOUT

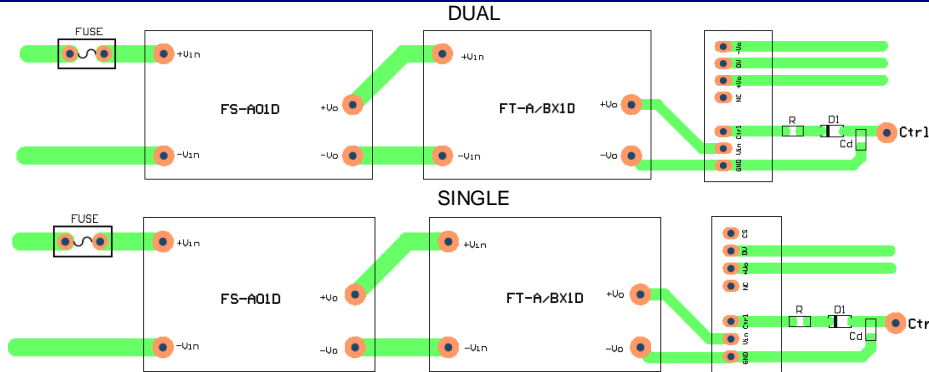

(Figure 4)

EMI TEST WAVEFORM (RECOMMENDED CIRCUIT FIGURE 1-②)

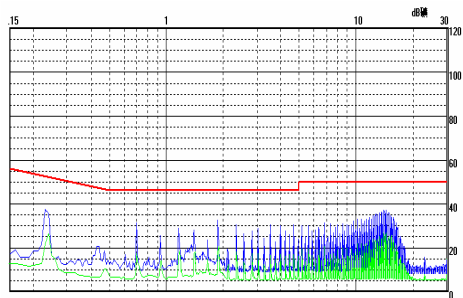

WRA2405S-1WR2 CE(Class B, Positive line)

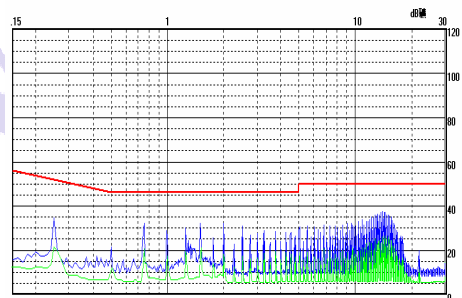

WRA2405S-1WR2 CE(Class B, Negative line)

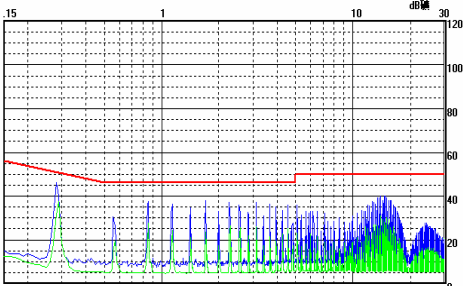

WRB2405S-1WR2 CE(Class B, Positive line)

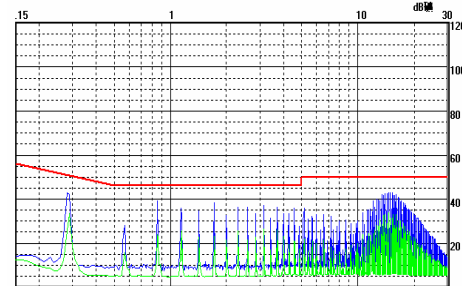

WRB2405S-1WR2 CE(Class B, Negative line)

PRODUCT TYPICAL PERFORMANCE CURVE

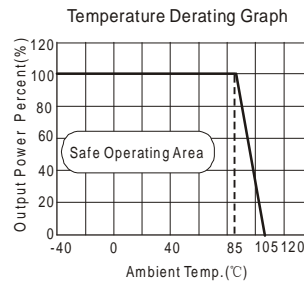

(Figure 5)

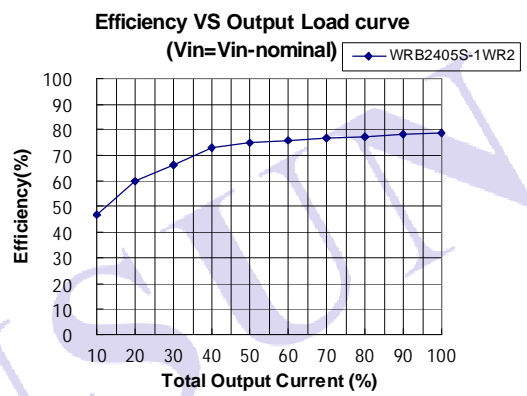
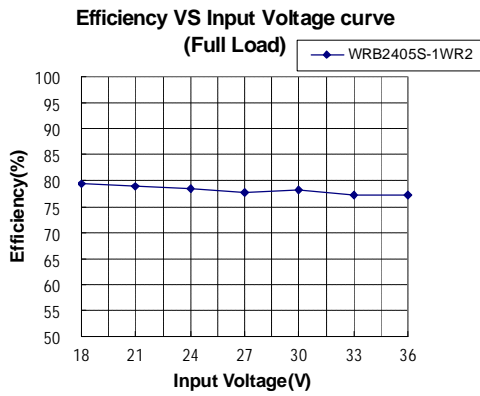
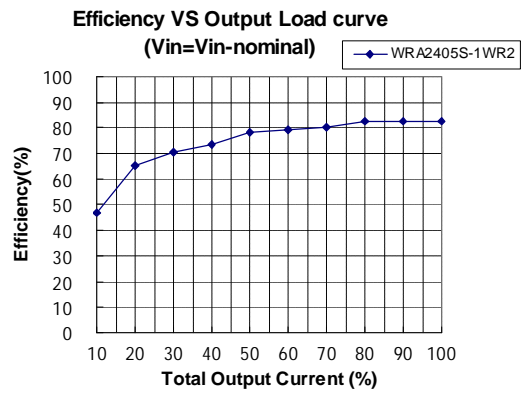
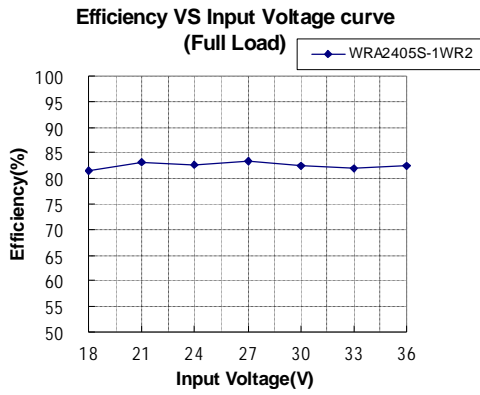

DIMENSIONS, RECOMMENDED FOOTPRINT & PACKAGING

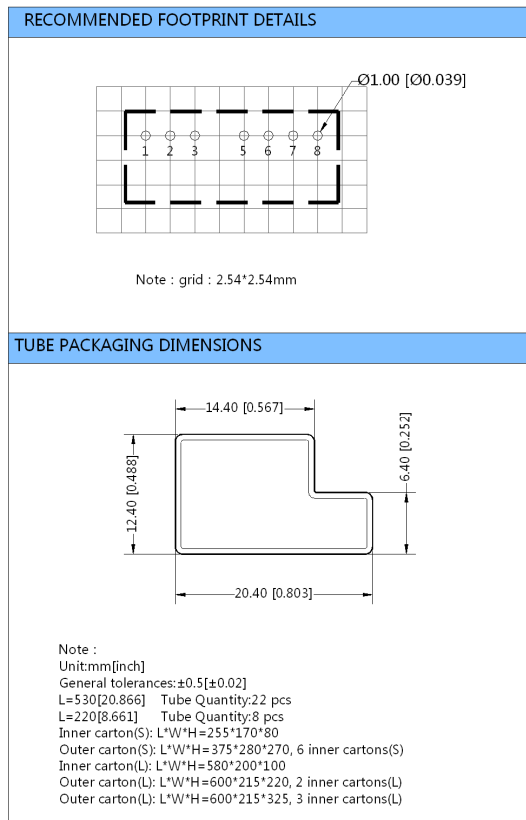
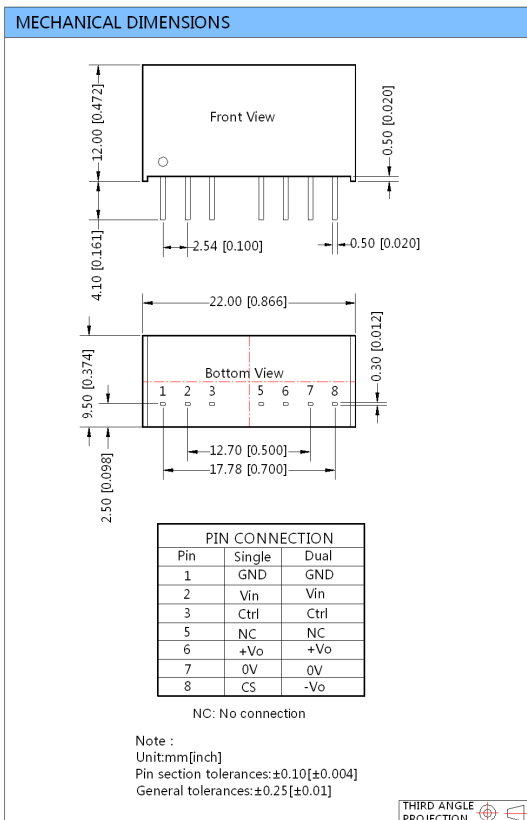

TEST CONFIGURATIONS

Input Reflected-Ripple Current Test Setup

Input reflected-ripple current is measured with an inductor L_{in} and Capacitor C_{in} to simulate the source impedance.

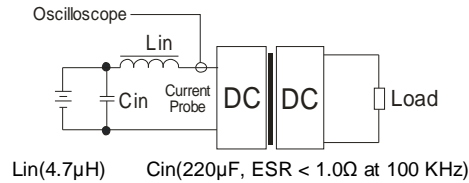

DESIGN CONSIDERATIONS

1) Requirement on output load

To ensure this module operate efficiently and reliably, during operation, the minimum output load could not be less than 5% of the full load, otherwise output ripple may increase dramatically. If the actual output power is very small, please connect a resistor with proper resistance at the output end in parallel to increase the load, suppose to use the resistance of 5% rated power, or use our company's products with a lower rated output power.

2) Recommended Circuit

All the WRA_S-1WR2 & WRB_S-1WR2 Series have been tested according to the following recommended test circuit before leaving the factory (see Figure 6).

If you want to further decrease the input/output ripple, increase the value of the capacitance properly or choose capacitors with low ESR. However, the capacitance of the output filter must be proper. If the capacitance is too big, a startup problem might arise. For every channel of output, under the condition of safe and reliable operation, the max capacitance must be less than the Max capacitive load.

General:	Cin1:	5V&12V	100µF
		24V&48V	10µF
	Cin2:	5V&12V	47µF
		24V&48V	1µF
	Lin:	4.7µH~12µH	
	Cs:	10µF~22µF	
	Cout:	100µF(Typ.)	
	Lout:	2.2µH~10µH	
	Cd:	47nF/100V	

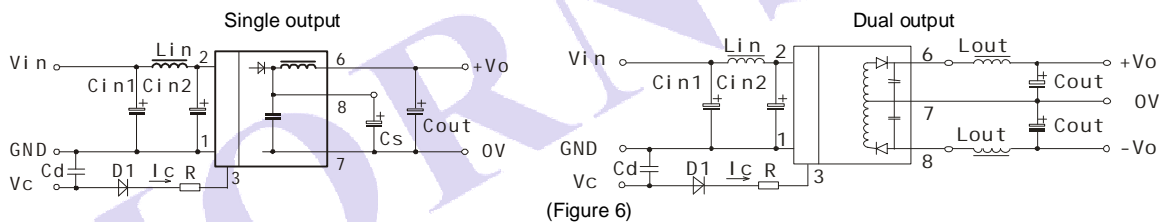

3) Ctrl Terminal

When being open or with high impedance, the converter works well; When its pin is connected to high level voltage, the converter shut down. It should be noticed that the input current should be between 5-10mA, exceeding the maximum current of 20mA will cause permanent damage to the converter. The value of R can be derived as follows:

$$R = \frac{V_C - V_D - 1.0}{I_C} - 300$$

For Detailed parameter, please refer to "EMC RECOMMENDED CIRCUIT".

4) Input Current

When it is used in unregulated power supply, be sure that the fluctuating range of the power supply and the rippled voltage do not exceed the standard of module. Input current of power supply should afford the flash startup average current of this kind of DC/DC module (Figure 7).

General:	Vin=5V	Iave =450mA
	Vin=12V	Iave =220mA
	Vin=24V	Iave =110mA
	Vin=48V	Iave =55 mA

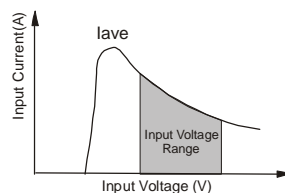

(Figure 7)

5) It is not recommended to increase the output power capability by connecting two or more converters in parallel. The product is not hot-swappable

Note:

1. Min. load shouldn't be less than 5%, otherwise ripple maybe increased dramatically. If the product operates under min. load, it may not be guaranteed to meet all specifications listed. Operation with minimum load will not damage the converter.
2. Recommended Dual output models unbalanced load is $\leq \pm 5\%$, if the product operates $> \pm 5\%$, it may not be guaranteed to meet all specifications listed. Please contact our technical support for more details.
3. Max. Capacitive Load is tested at nominal input voltage and full load.
4. All specifications measured at $T_a=25^\circ\text{C}$, humidity $<75\%$, nominal input voltage and rated output load unless otherwise specified.
5. In this datasheet, all test methods are based on our corporate standards.
6. All characteristics are for listed models, and non-standard models may perform differently. Please contact our technical support for more details.
7. Please contact our technical support for any specific requirement.
8. Specifications of this product are subject to changes without prior notice.

MORNSUN Science & Technology Co.,Ltd.

Address: No. 5, Kehui St. 1, Kehui development center, Science Ave., Guangzhou Science City, Luogang district, Guangzhou, P.R.China.

Tel: 86-20-38601850

Fax: 86-20-38601272

E-mail: info@mornsun.cn

[Http://www.mornsun-power.com](http://www.mornsun-power.com)

MORNSUN