

1N5221B - 1N5263B Zener Diodes

Tolerance = 5%



DO-35 Glass case
COLOR BAND DENOTES CATHODE

Absolute Maximum Ratings

Stresses exceeding the absolute maximum ratings may damage the device. The device may not function or be operable above the recommended operating conditions and stressing the parts to these levels is not recommended. In addition, extended exposure to stresses above the recommended operating conditions may affect device reliability. The absolute maximum ratings are stress ratings only. Values are at $T_A = 25^\circ\text{C}$ unless otherwise noted.

Symbol	Parameter	Value	Units
P_D	Power Dissipation	500	mW
	Derate above 50°C	4.0	mW°C
T_{STG}	Storage Temperature Range	-65 to +200	$^\circ\text{C}$
T_J	Operating Junction Temperature Range	-65 to +200	$^\circ\text{C}$
	Lead Temperature (1/16 inch from case for 10 s)	+230	$^\circ\text{C}$

Note:

- These ratings are limiting values above which the serviceability of any semiconductor device may be impaired.
Non-recurrent square wave Pulse Width = 8.3 ms, $T_A = 50^\circ\text{C}$

Electrical Characteristics

Values are at $T_A = 25^\circ\text{C}$ unless otherwise noted .

Device	V_Z (V) @ I_Z (2)			Z_Z (Ω) @ I_Z (mA)		Z_{ZK} (Ω) @ I_{ZK} (mA)		I_R (μA) @ V_R (V)		T_C (%/°C)
	Min.	Typ.	Max.							
1N5221B	2.28	2.4	2.52	30	20	1,200	0.25	100	1.0	-0.085
1N5222B	2.375	2.5	2.625	30	20	1,250	0.25	100	1.0	-0.085
1N5223B	2.565	2.7	2.835	30	20	1,300	0.25	75	1.0	-0.080
1N5224B	2.66	2.8	2.94	30	20	1,400	0.25	75	1.0	-0.080
1N5225B	2.85	3	3.15	29	20	1,600	0.25	50	1.0	-0.075
1N5226B	3.135	3.3	3.465	28	20	1,600	0.25	25	1.0	-0.07
1N5227B	3.42	3.6	3.78	24	20	1,700	0.25	15	1.0	-0.065
1N5228B	3.705	3.9	4.095	23	20	1,900	0.25	10	1.0	-0.06
1N5229B	4.085	4.3	4.515	22	20	2,000	0.25	5.0	1.0	+/-0.055
1N5230B	4.465	4.7	4.935	19	20	1,900	0.25	2.0	1.0	+/-0.03
1N5231B	4.845	5.1	5.355	17	20	1,600	0.25	5.0	2.0	+/-0.03
1N5232B	5.32	5.6	5.88	11	20	1,600	0.25	5.0	3.0	0.038
1N5233B	5.7	6	6.3	7.0	20	1,600	0.25	5.0	3.5	0.038
1N5234B	5.89	6.2	6.51	7.0	20	1,000	0.25	5.0	4.0	0.045
1N5235B	6.46	6.8	7.14	5.0	20	750	0.25	3.0	5.0	0.05
1N5236B	7.125	7.5	7.875	6.0	20	500	0.25	3.0	6.0	0.058
1N5237B	7.79	8.2	8.61	8.0	20	500	0.25	3.0	6.5	0.062
1N5238B	8.265	8.7	9.135	8.0	20	600	0.25	3.0	6.5	0.065
1N5239B	8.645	9.1	9.555	10	20	600	0.25	3.0	7.0	0.068
1N5240B	9.5	10	10.5	17	20	600	0.25	3.0	8.0	0.075
1N5241B	10.45	11	11.55	22	20	600	0.25	2.0	8.4	0.076
1N5242B	11.4	12	12.6	30	20	600	0.25	1.0	9.1	0.077
1N5243B	12.35	13	13.65	13	9.5	600	0.25	0.5	9.9	0.079
1N5244B	13.3	14	14.7	15	9.0	600	0.25	0.1	10	0.080
1N5245B	14.25	15	15.75	16	8.5	600	0.25	0.1	11	0.082
1N5246B	15.2	16	16.8	17	7.8	600	0.25	0.1	12	0.083
1N5247B	16.15	17	17.85	19	7.4	600	0.25	0.1	13	0.084
1N5248B	17.1	18	18.9	21	7.0	600	0.25	0.1	14	0.085
1N5249B	18.05	19	19.95	23	6.6	600	0.25	0.1	14	0.085
1N5250B	19	20	21	25	6.2	600	0.25	0.1	15	0.086
1N5251B	20.9	22	23.1	29	5.6	600	0.25	0.1	17	0.087
1N5252B	22.8	24	25.2	33	5.2	600	0.25	0.1	18	0.088
1N5253B	23.75	25	26.25	35	5.0	600	0.25	0.1	19	0.088
1N5254B	25.65	27	28.35	41	4.6	600	0.25	0.1	21	0.089
1N5255B	26.6	28	29.4	44	4.5	600	0.25	0.1	21	0.090
1N5256B	28.5	30	31.5	49	4.2	600	0.25	0.1	23	0.09
1N5257B	31.35	33	34.65	58	3.8	700	0.25	0.1	25	0.092
1N5258B	34.2	36	37.8	70	3.4	700	0.25	0.1	27	0.093
1N5259B	37.05	39	40.95	80	3.2	800	0.25	0.1	30	0.094
1N5260B	40.85	43	45.15	93	3.0	900	0.25	0.1	33	0.095
1N5261B	44.65	47	49.35	105	2.7	1000	0.25	0.1	36	0.095
1N5262B	48.45	51	53.55	125	2.5	1100	0.25	0.1	39	0.096
1N5263B	53.2	56	58.8	150	2.2	1300	0.25	0.1	43	0.096

V_F Forward Voltage = 1.2V Max. @ $I_F = 200\text{mA}$

Note:

2. Zener Voltage (V_Z)

The zener voltage is measured with the device junction in the thermal equilibrium at the lead temperature (T_L) at $30^\circ\text{C} \pm 1^\circ\text{C}$ and 3/8" lead length.

Top Mark Information

Device	Line 1	Line 2	Line 3
1N5221B	LOGO	22	1B
1N5222B	LOGO	22	2B
1N5223B	LOGO	22	3B
1N5224B	LOGO	22	4B
1N5225B	LOGO	22	5B
1N5226B	LOGO	22	6B
1N5227B	LOGO	22	7B
1N5228B	LOGO	22	8B
1N5229B	LOGO	22	9B
1N5230B	LOGO	23	0B
1N5231B	LOGO	23	1B
1N5232B	LOGO	23	2B
1N5233B	LOGO	23	3B
1N5234B	LOGO	23	4B
1N5235B	LOGO	23	5B
1N5236B	LOGO	23	6B
1N5237B	LOGO	23	7B
1N5238B	LOGO	23	8B
1N5239B	LOGO	23	9B
1N5240B	LOGO	24	0B
1N5241B	LOGO	24	1B
1N5242B	LOGO	24	2B
1N5243B	LOGO	24	3B
1N5244B	LOGO	24	4B
1N5245B	LOGO	24	5B
1N5246B	LOGO	24	6B
1N5247B	LOGO	24	7B
1N5248B	LOGO	24	8B
1N5249B	LOGO	24	9B
1N5250B	LOGO	25	0B
1N5251B	LOGO	25	1B
1N5252B	LOGO	25	2B
1N5253B	LOGO	25	3B
1N5254B	LOGO	25	4B
1N5255B	LOGO	25	5B
1N5256B	LOGO	25	6B
1N5257B	LOGO	25	7B
1N5258B	LOGO	25	8B
1N5259B	LOGO	25	9B
1N5260B	LOGO	26	0B
1N5261B	LOGO	26	1B
1N5262B	LOGO	26	2B
1N5263B	LOGO	26	3B

Top Mark Information (Continued)

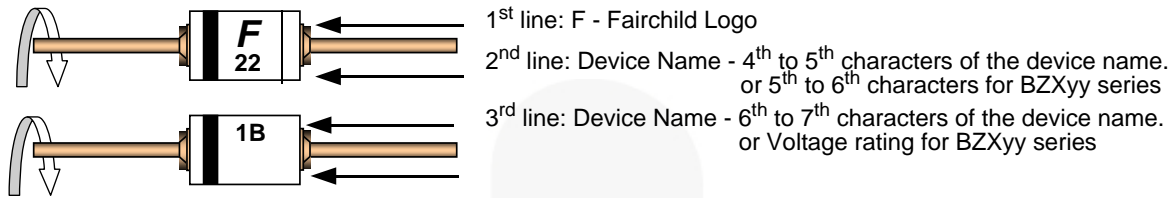

General Requirements:

- 1.0 Cathode Band
- 2.0 First Line: F - Fairchild Logo
- 3.0 Second Line: Device name - For 1Nxx series: 4th to 5th characters of the device name.
 For BZxx series: 5th to 6th characters of the device name.
- 4.0 Third Line: Device name - For 1Nxx series: 6th to 7th characters of the device name.
 For BZXyy series: Voltage rating
- 5.0 Devices shall be marked as required in the device specification (PID or FSC Test Spec).
- 6.0 Maximum no. of marking lines: 3
- 7.0 Maximum no. of digits per line: 2
- 8.0 FSC logo must be 20 % taller than the alphanumeric marking and should occupy the 2 characters of the specified line.
- 9.0 Marking Font: Arial (Except FSC Logo)
- 10.0 First character of each marking line must be aligned vertically.
- 11.0 All device markings must be based on Fairchild device specification.

Physical Dimensions

DO-35

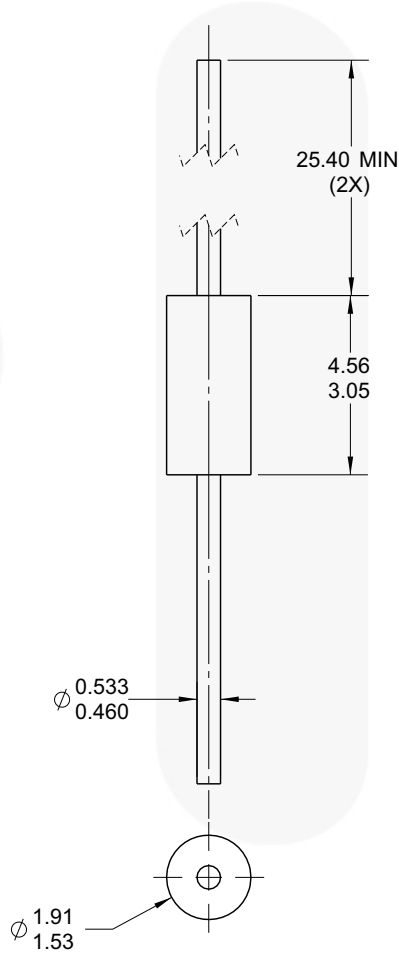

NOTES: UNLESS OTHERWISE SPECIFIED

- A) PACKAGE STANDARD REFERENCE:
JEDEC DO-204, VARIATION AH.
- B) HERMETICALLY SEALED GLASS PACKAGE.
- C) PACKAGE WEIGHT IS 0.137 GRAM.
- D) ALL DIMENSIONS ARE IN MILLIMETERS.
- E) DRAWING FILE NAME: DO35AREV02

Figure 1. AXIAL LEADED; GLASS; JEDEC DO204; VARIATION AH (ACTIVE)

Package drawings are provided as a service to customers considering Fairchild components. Drawings may change in any manner without notice. Please note the revision and/or date on the drawing and contact a Fairchild Semiconductor representative to verify or obtain the most recent revision. Package specifications do not expand the terms of Fairchild's worldwide terms and conditions, specifically the warranty therein, which covers Fairchild products.

Always visit Fairchild Semiconductor's online packaging area for the most recent package drawings:

<http://www.fairchildsemi.com/dwg/DO/DO35A.pdf>





For current tape and reel specifications, visit Fairchild Semiconductor's online packaging area:

http://www.fairchildsemi.com/packing_dwg/PKG-DO35A_TC.pdf



TRADEMARKS

The following includes registered and unregistered trademarks and service marks, owned by Fairchild Semiconductor and/or its global subsidiaries, and is not intended to be an exhaustive list of all such trademarks.

- | | | | |
|---|--|---|---|
| 2Cool™ | FPS™ |  | Sync-Lock™ |
| AccuPower™ | F-PFS™ | PowerTrench® |  |
| AX-CAP®* | FRFET® | PowerXS™ | TinyBoost™ |
| BitSiC™ | Global Power Resource SM | Programmable Active Droop™ | TinyBuck™ |
| Build it Now™ | GreenBridge™ | QFET® | TinyCalc™ |
| CorePLUS™ | Green FPS™ | QS™ | TinyLogic® |
| CorePOWER™ | Green FPS™ e-Series™ | Quiet Series™ | TINYOPTO™ |
| CROSSVOLT™ | Gmax™ | RapidConfigure™ | TinyPower™ |
| CTL™ | GTO™ |  | TinyPWM™ |
| Current Transfer Logic™ | IntelliMAX™ | Saving our world, 1mW/W/kW at a time™ | TinyWire™ |
| DEUXPEED® | ISOPLANAR™ | SignalWise™ | TranSiC™ |
| Dual Cool™ | Making Small Speakers Sound Louder and Better™ | SmartMax™ | TriFault Detect™ |
| EcoSPARK® | MegaBuck™ | SMART START™ | TRUECURRENT®* |
| EfficientMax™ | MICROCOUPLER™ | Solutions for Your Success™ | µSerDes™ |
| ESBC™ | MicroFET™ | SPM® |  |
|  | MicroPak™ | STEALTH™ | UHC® |
| Fairchild® | MicroPak2™ | SuperFET® | Ultra FRFET™ |
| Fairchild Semiconductor® | MillerDrive™ | SuperSOT™-3 | UniFET™ |
| FACT Quiet Series™ | MotionMax™ | SuperSOT™-6 | VCX™ |
| FACT® | mWSaver™ | SuperSOT™-8 | VisualMax™ |
| FAST® | OptoHiT™ | SupreMOS® | VoltagePlus™ |
| FastvCore™ | OPTOLOGIC® | SyncFET™ | XS™ |
| FETBench™ | OPTOPLANAR® | | |

* Trademarks of System General Corporation, used under license by Fairchild Semiconductor.

DISCLAIMER

FAIRCHILD SEMICONDUCTOR RESERVES THE RIGHT TO MAKE CHANGES WITHOUT FURTHER NOTICE TO ANY PRODUCTS HEREIN TO IMPROVE RELIABILITY, FUNCTION, OR DESIGN. FAIRCHILD DOES NOT ASSUME ANY LIABILITY ARISING OUT OF THE APPLICATION OR USE OF ANY PRODUCT OR CIRCUIT DESCRIBED HEREIN; NEITHER DOES IT CONVEY ANY LICENSE UNDER ITS PATENT RIGHTS, NOR THE RIGHTS OF OTHERS. THESE SPECIFICATIONS DO NOT EXPAND THE TERMS OF FAIRCHILD'S WORLDWIDE TERMS AND CONDITIONS, SPECIFICALLY THE WARRANTY THEREIN, WHICH COVERS THESE PRODUCTS.

LIFE SUPPORT POLICY

FAIRCHILD'S PRODUCTS ARE NOT AUTHORIZED FOR USE AS CRITICAL COMPONENTS IN LIFE SUPPORT DEVICES OR SYSTEMS WITHOUT THE EXPRESS WRITTEN APPROVAL OF FAIRCHILD SEMICONDUCTOR CORPORATION.

As used herein:

1. Life support devices or systems are devices or systems which, (a) are intended for surgical implant into the body or (b) support or sustain life, and (c) whose failure to perform when properly used in accordance with instructions for use provided in the labeling, can be reasonably expected to result in a significant injury of the user.
2. A critical component in any component of a life support, device, or system whose failure to perform can be reasonably expected to cause the failure of the life support device or system, or to affect its safety or effectiveness.

ANTI-COUNTERFEITING POLICY

Fairchild Semiconductor Corporation's Anti-Counterfeiting Policy. Fairchild's Anti-Counterfeiting Policy is also stated on our external website, www.fairchildsemi.com, under Sales Support.

Counterfeiting of semiconductor parts is a growing problem in the industry. All manufacturers of semiconductor products are experiencing counterfeiting of their parts. Customers who inadvertently purchase counterfeit parts experience many problems such as loss of brand reputation, substandard performance, failed applications, and increased cost of production and manufacturing delays. Fairchild is taking strong measures to protect ourselves and our customers from the proliferation of counterfeit parts. Fairchild strongly encourages customers to purchase Fairchild parts either directly from Fairchild or from Authorized Fairchild Distributors who are listed by country on our web page cited above. Products customers buy either from Fairchild directly or from Authorized Fairchild Distributors are genuine parts, have full traceability, meet Fairchild's quality standards for handling and storage and provide access to Fairchild's full range of up-to-date technical and product information. Fairchild and our Authorized Distributors will stand behind all warranties and will appropriately address any warranty issues that may arise. Fairchild will not provide any warranty coverage or other assistance for parts bought from Unauthorized Sources. Fairchild is committed to combat this global problem and encourage our customers to do their part in stopping this practice by buying direct or from authorized distributors.

PRODUCT STATUS DEFINITIONS

Definition of Terms

Datasheet Identification	Product Status	Definition
Advance Information	Formative / In Design	Datasheet contains the design specifications for product development. Specifications may change in any manner without notice.
Preliminary	First Production	Datasheet contains preliminary data; supplementary data will be published at a later date. Fairchild Semiconductor reserves the right to make changes at any time without notice to improve design.
No Identification Needed	Full Production	Datasheet contains final specifications. Fairchild Semiconductor reserves the right to make changes at any time without notice to improve the design.
Obsolete	Not In Production	Datasheet contains specifications on a product that is discontinued by Fairchild Semiconductor. The datasheet is for reference information only.