

AX22X4

The Acriche series of LEDs are designed for AC operation and high flux output applications. Acriche LEDs are an environmentally friendly semiconductor lighting source that can be directly connected to an AC power source without any DC conversion required.

Acriche's thermal management performance exceeds other power LED solutions by incorporating state-of-the-art SMD design and use of specialized thermal emission material. Acriche is an ideal light source for general purpose illumination applications



AX22X4

Features

- Connect directly to AC power
- Power Saving
- Long Life
- Simplified B.O.M
- Small design footprint
- Low thermal resistance
- SMT solderability
- Lead Free and RoHS compliant

Application

- Architectural lighting
- Task lighting
- Decorative and Pathway lighting
- White goods and gaming
- Spot lighting

* product specification may change without notice

Part number of AX22X4

1. Part Number form : A X₁ X₂ X₃ X₄ X₅

X ₁	Color
W	Pure White
N	Warm White

X ₂	Acriche Series
2	A2

X ₃	LENS Type
2	Dome Type

X ₄	Operating Voltage [V]
0	100
1	110

X ₅	PCB Type
0	Emitter
4	PCB

Outline dimensions

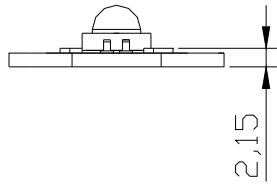
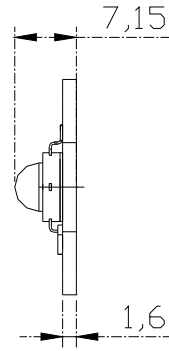
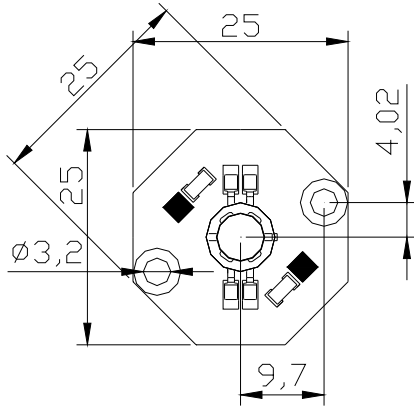

Notes :

1. All dimensions are in millimeters. (tolerance : ± 0.2)
2. Scale : none
3. Drawings without tolerances are for reference only
4. Slug of package isn't connected to anode or cathode

Characteristics of Acriche

1. Pure white – AW2204, AW2214

1-1 Electro-Optical characteristics at 100V/110V RMS, $T_A=25^{\circ}\text{C}$

Parameter	Symbol	Value			Unit
		Min	Typ	Max	
Luminous Flux ^[1]	Φ_V ^[2]	-	80	-	lm
Illuminance ^[3]	Φ_l		91		lux
Correlated Color Temperature ^[4]	CCT	-	6300	-	K
CRI	R_a	-	70	-	-
Operating Current	I_{opt}	-	20	-	mA[RMS]
Power Dissipation	P_D	2			W
Operating Frequency	Freq	50 / 60			Hz
View Angle	2θ 1/2	110			deg.

1-2 Absolute Maximum Ratings

Parameter	Symbol	Value	Unit
Operating Voltage	V_{opt} ^[5]	115/127	V [RMS]
Power Dissipation	P_D	4.3	W
Junction Temperature	T_j	125	$^{\circ}\text{C}$
Operating Temperature	T_{opr}	-30 ~ +85	$^{\circ}\text{C}$
Storage Temperature	T_{stg}	-40 ~ +120	$^{\circ}\text{C}$
ESD Sensitivity	-	$\pm 2,000\text{V}$ HBM	-

*Notes :

- [1] Acriche series maintains a tolerance of $\pm 10\%$ on flux and power measurements.
- [2] Φ_V is the total luminous flux output as measured with an integrating sphere.
- [3] Illuminance is measured at 50cm distance
- [4] Correlated Color Temperature is derived from the CIE 1931 Chromaticity diagram.
CCT $\pm 5\%$ tester tolerance
- [5] 'Operating Voltage' doesn't indicate the maximum voltage which customers use, but it means tolerable voltage according to the voltage variation rate by one's country.
It is recommended that the temperature of lead frame should be below 70°C .



Lead Temperature

Characteristics of Acriche

2 Warm white – AN2204, AN2214

2-1 Electro-Optical characteristics at 100V/110V RMS, $T_A=25^{\circ}\text{C}$

Parameter	Symbol	Value			Unit
		Min	Typ	Max	
Luminous Flux ^[1]	Φ_V ^[2]	-	65	-	lm
Illuminance ^[3]	Φ_l		73		lux
Correlated Color Temperature ^[4]	CCT	-	3000	-	K
CRI	R_a	-	80	-	-
Operating Current	I_{opt}	-	20	-	mA[RMS]
Power Dissipation	P_D	2			W
Operating Frequency	Freq	50 / 60			Hz
View Angle	2θ 1/2	110			deg.

2-2 Absolute Maximum Ratings

Parameter	Symbol	Value	Unit
Operating Voltage	V_{opt} ^[5]	115/127	V [RMS]
Power Dissipation	P_D	4.3	W
Junction Temperature	T_j	125	$^{\circ}\text{C}$
Operating Temperature	T_{opr}	-30 ~ +85	$^{\circ}\text{C}$
Storage Temperature	T_{stg}	-40 ~ +120	$^{\circ}\text{C}$
ESD Sensitivity	-	$\pm 2,000\text{V}$ HBM	-

*Notes :

- [1] Acriche series maintains a tolerance of $\pm 10\%$ on flux and power measurements.
- [2] Φ_V is the total luminous flux output as measured with an integrating sphere.
- [3] Illuminance is measured at 50cm distance
- [4] Correlated Color Temperature is derived from the CIE 1931 Chromaticity diagram.
CCT $\pm 5\%$ tester tolerance
- [5] 'Operating Voltage' doesn't indicate the maximum voltage which customers use, but it means tolerable voltage according to the voltage variation rate by one's country.
It is recommended that the temperature of lead frame should be below 70°C .

Color spectrum, Ta=25°C

1. Pure white

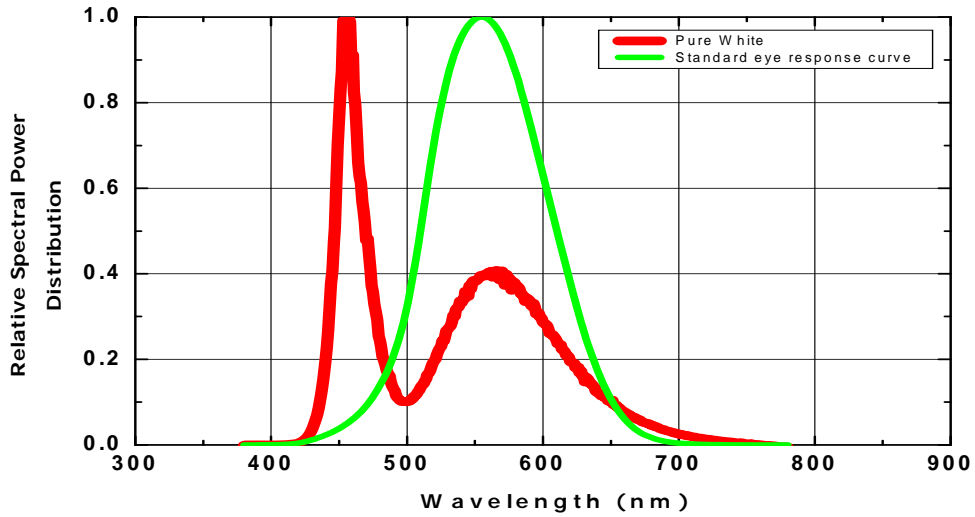

2. Warm white

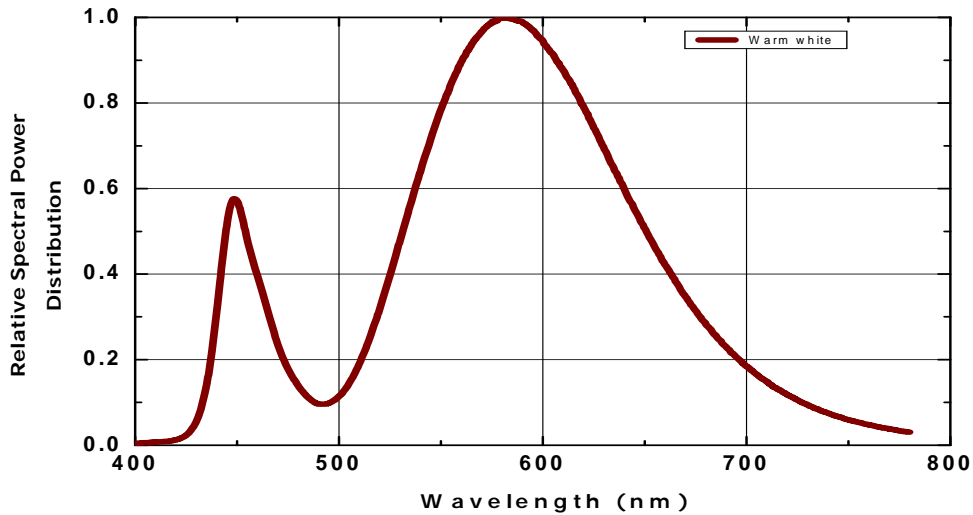

Current – Voltage characteristics, Ta=25°C

1. Current[RMS] vs Voltage[RMS] - 100V

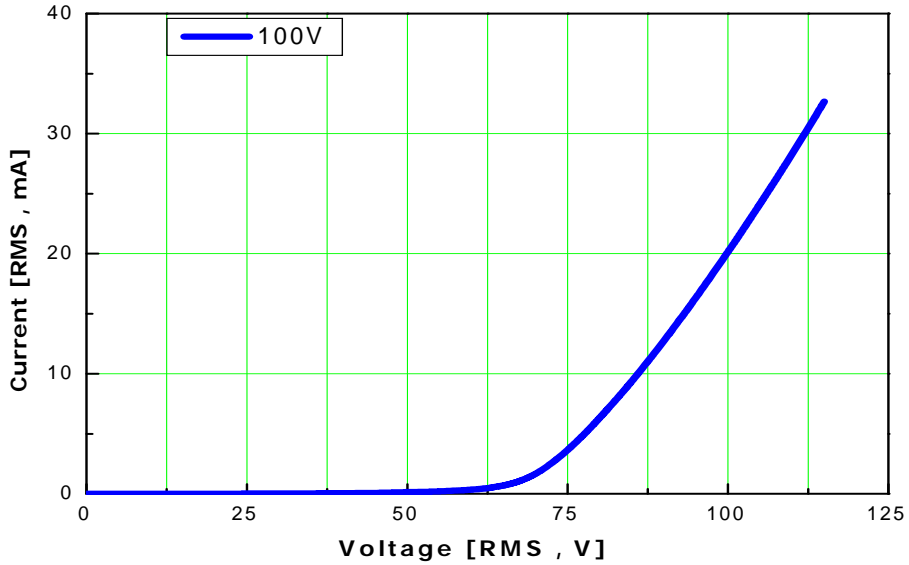

2. Current[RMS] vs Voltage[RMS] - 110V

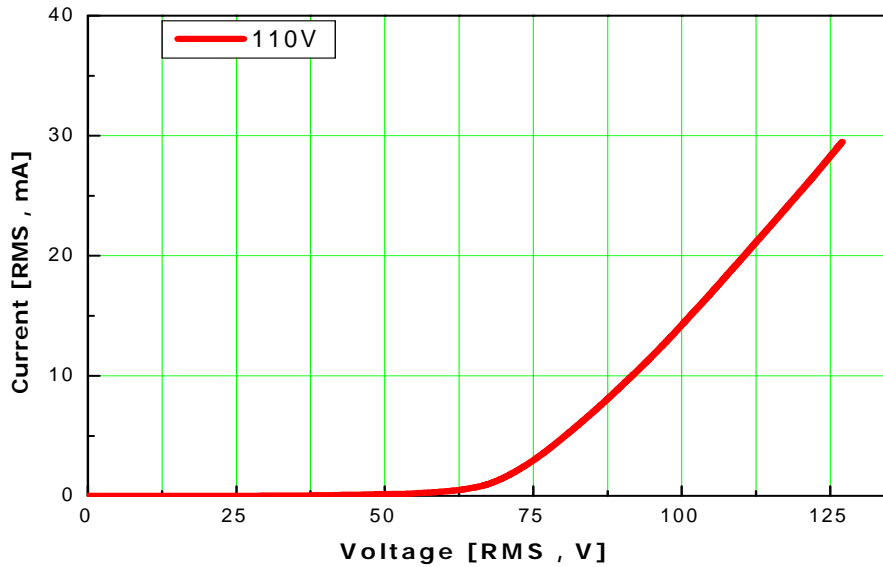

Voltage – Relative flux characteristics, Ta=25°C

1. Voltage[RMS] vs. Normalized Relative Luminous Flux -100V

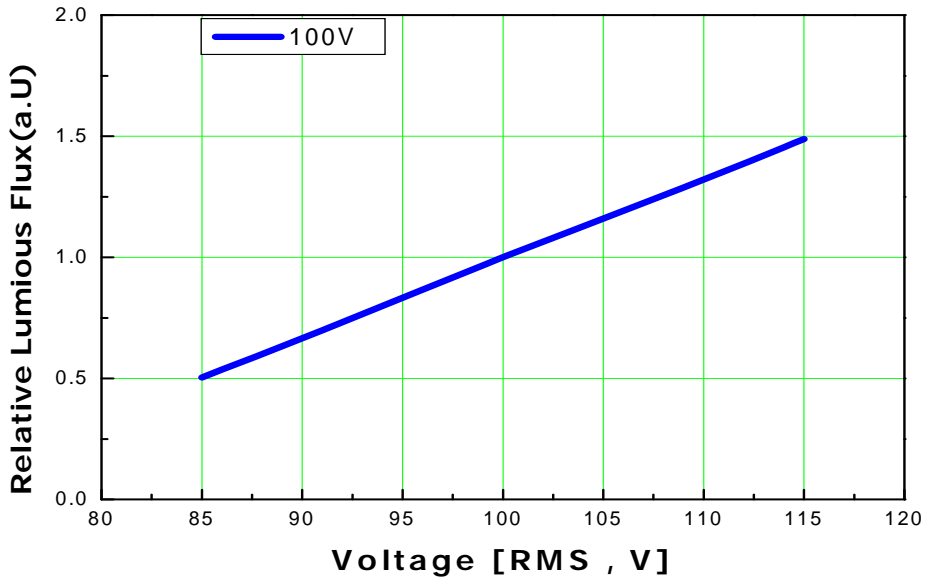

2. Voltage[RMS] vs. Normalized Relative Luminous Flux -110V

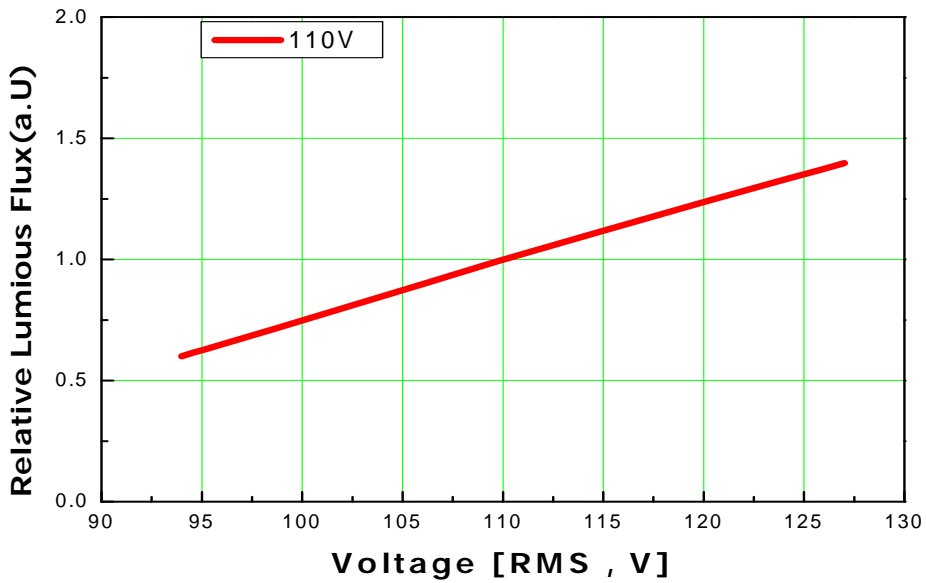

Voltage – XY Coordinate Shift, Ta=25°C

1. Voltage[RMS] vs. XY Coordinate Shift -100V

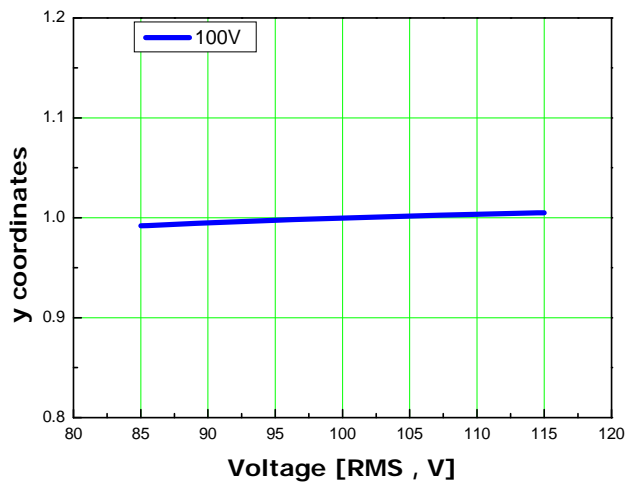
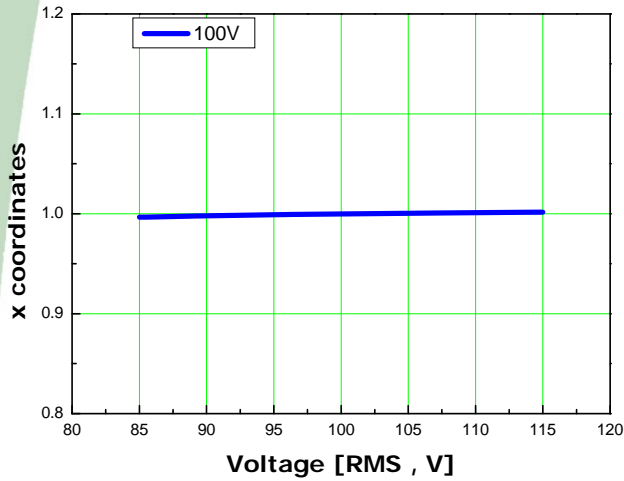

2. Voltage[RMS] vs. XY Coordinate Shift -110V

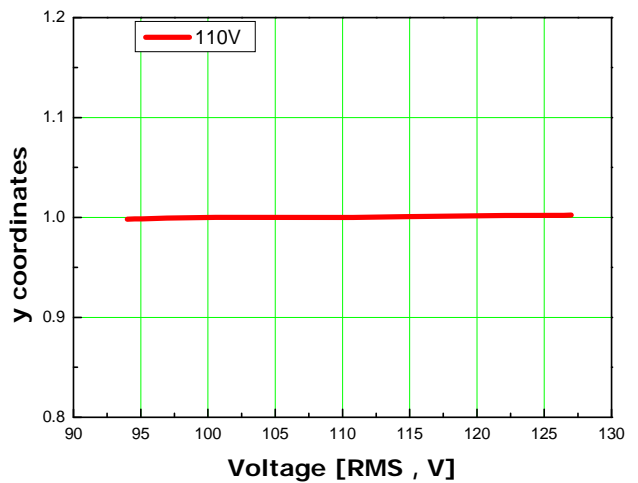
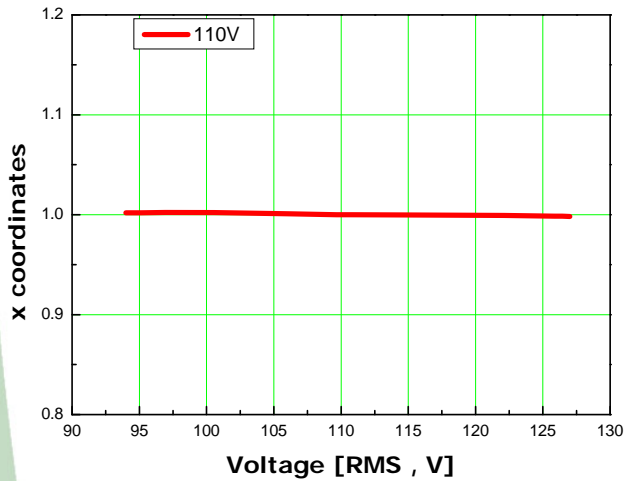

Voltage - Color Temperature Shift, Ta=25°C

1. Voltage[RMS] vs. Color Temperature Shift -100V

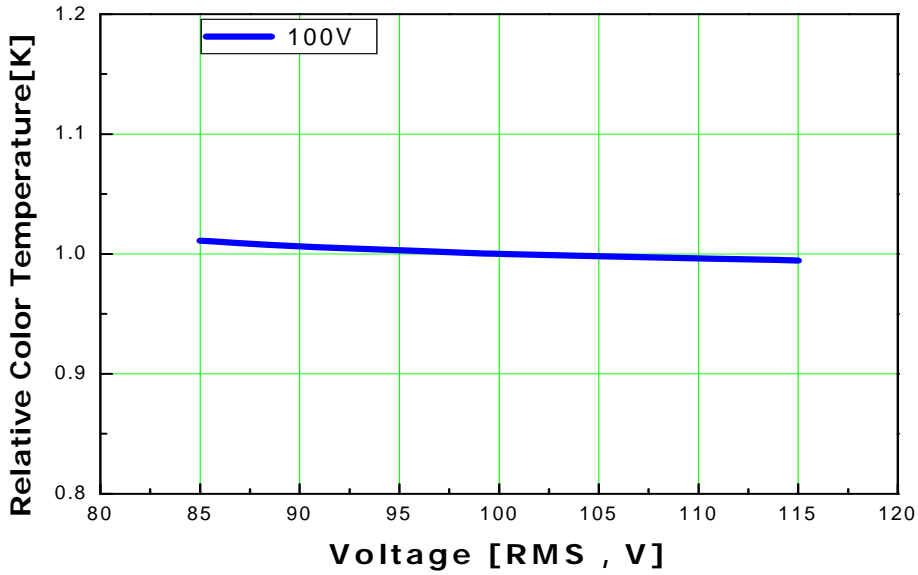

2. Voltage[RMS] vs. Color Temperature Shift -110V

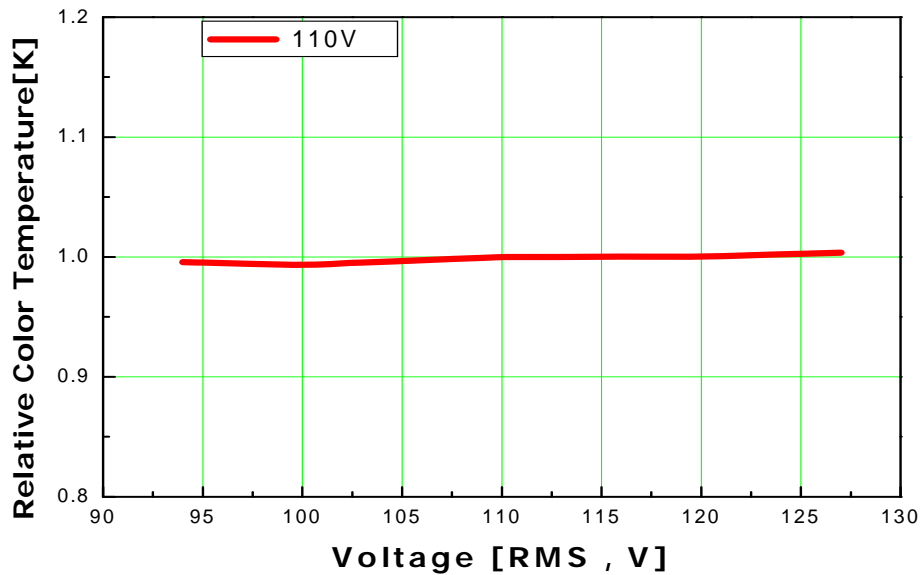

Relative Flux – Lead temperature characteristics

1. Pure white

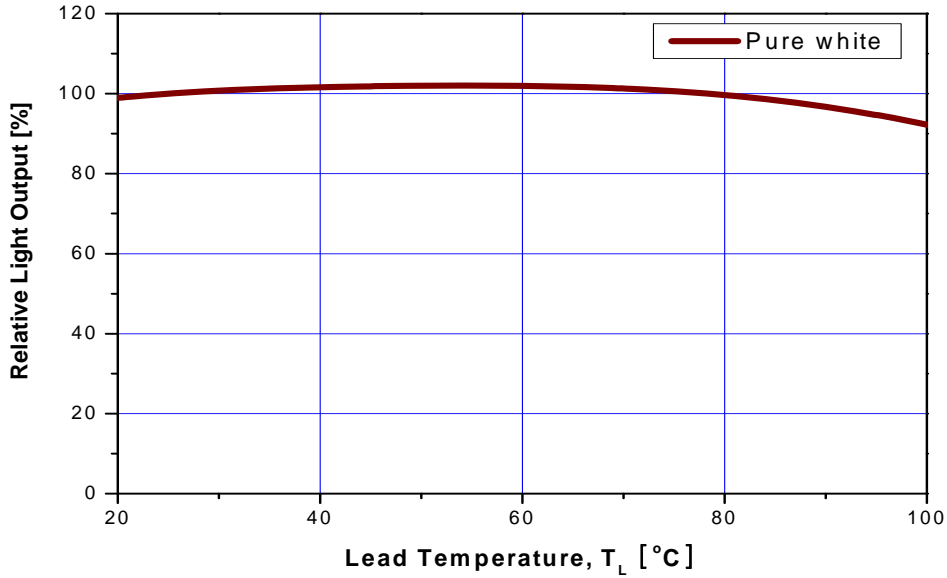

2. Warm white

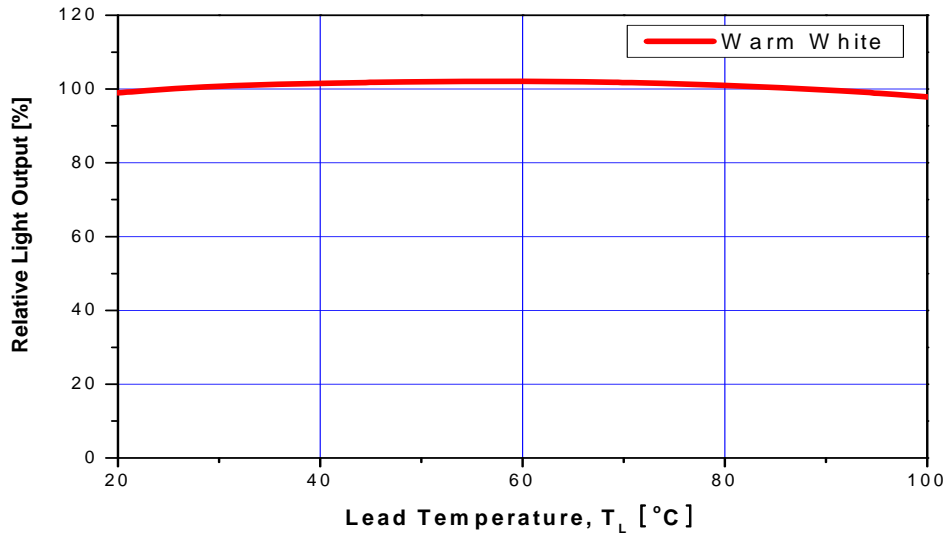

Typical Dome Type Radiation pattern

1. Pure White, Warm White

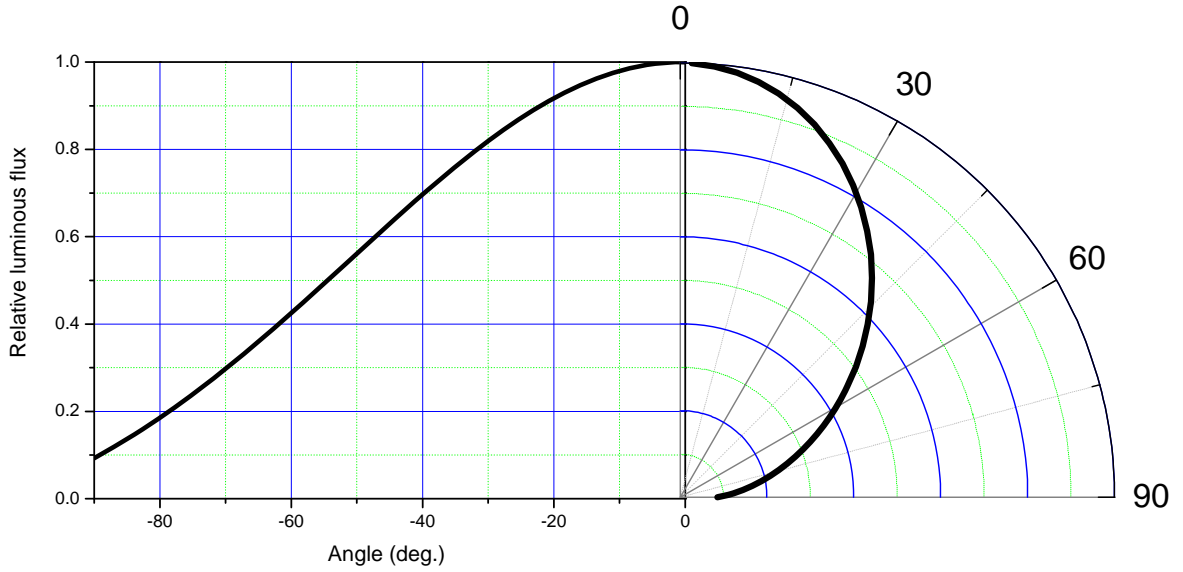

Acriche Binning structure graphical representation

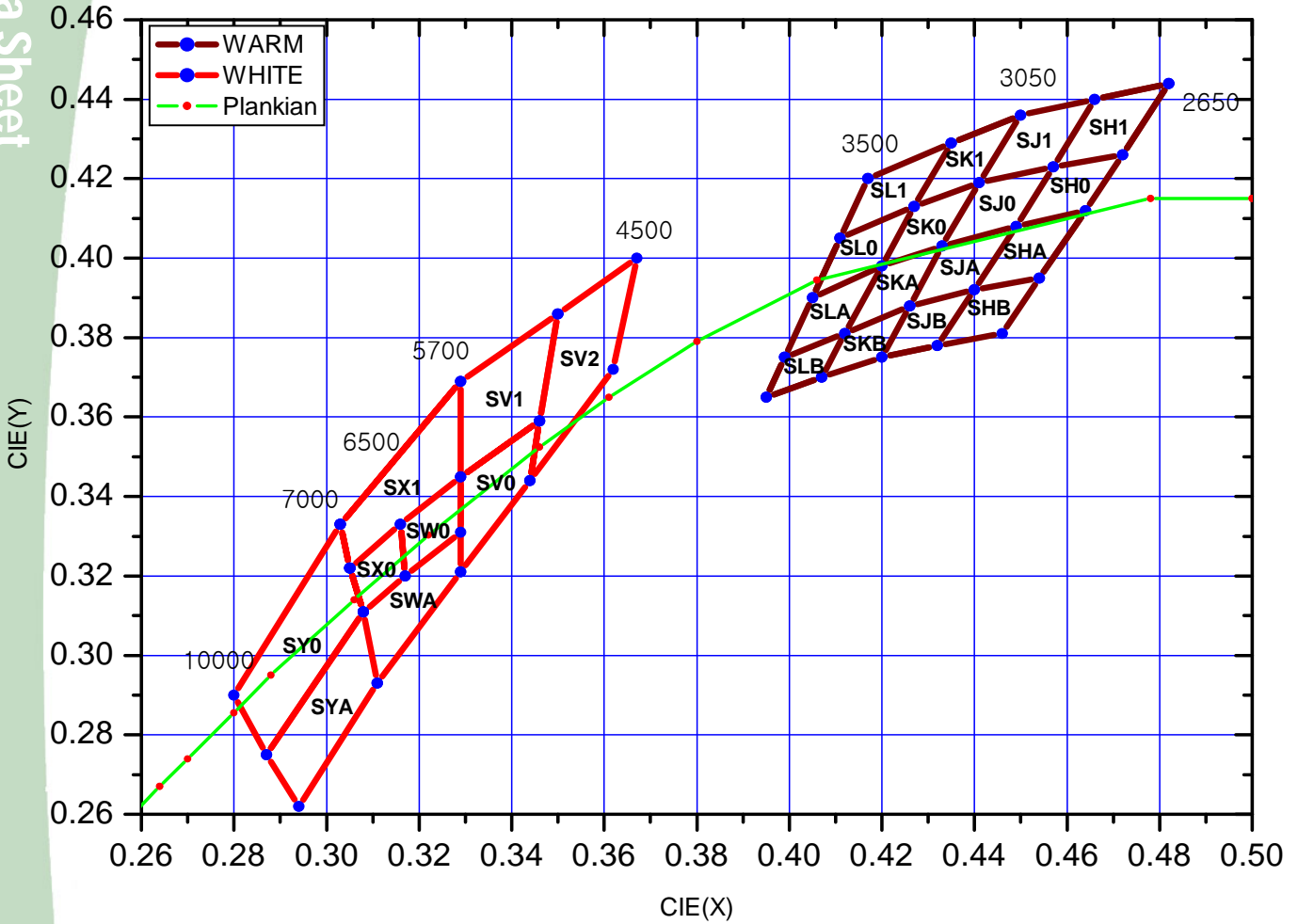

PCB type Reel Packaging

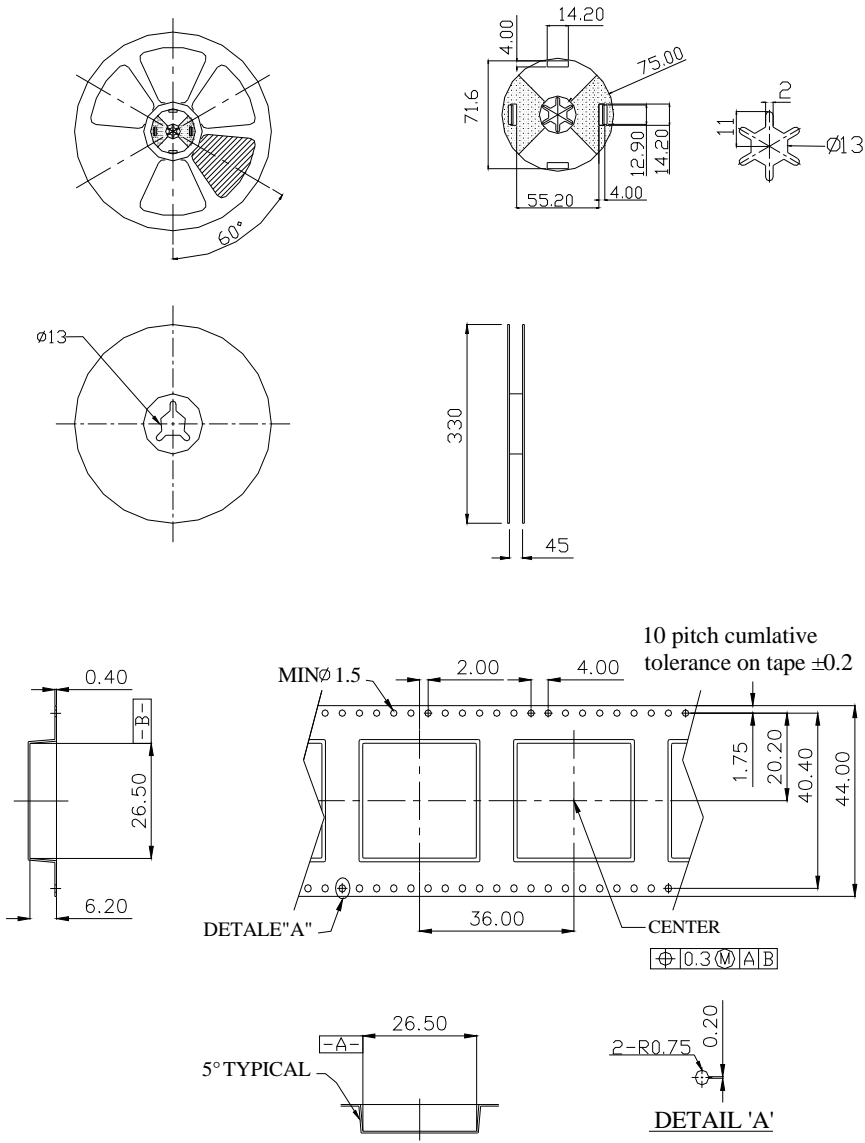

Note :

1. The number of loaded products in the reel is 100ea
2. All dimensions are in millimeters (tolerance : ± 0.2)
3. Scale none

*The appearance and specifications of the product may be changed for improvement without notice.

Packaging Structure

Aluminum Vinyl Bag

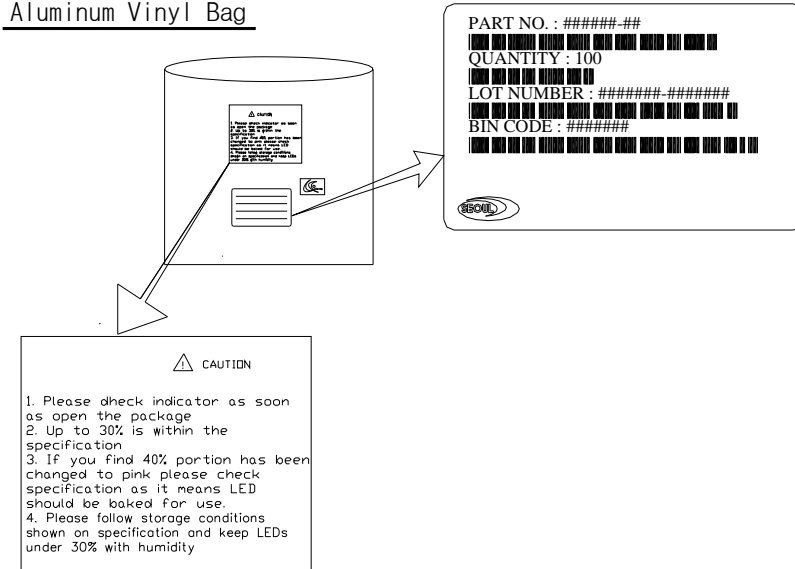

Outer Box

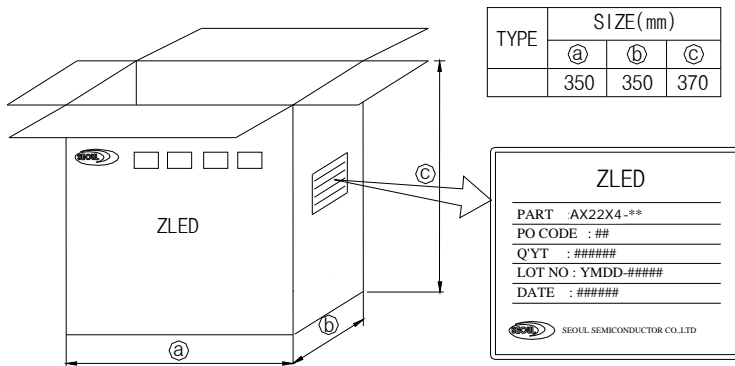

Note :

1. 6 reels are loaded in box
2. Scale none
3. For more information about binning and labeling, refer to the Application Note - 1

Precaution for use

- [1] Please note Acriche runs on high voltage so use caution when near the leads or if a dome is inadvertently removed while circuit is active
- [2] Please do not touch any of the circuit board, components or terminals with bare hands or metal while circuit is electrically active.
- [3] Please do not add or change wires while Acriche circuit is active

Handling of silicone resin for LEDs

- [1] Acriche series is encapsulated by silicone resin for the highest flux efficiency.
- [2] Avoid touching silicone resin portion of LED especially with sharp tools such as Pincette (tweezers).
- [3] Avoid leaving fingerprints on silicone resin parts.
- [4] Silicone resin is dust sensitive and needs a covered container for storage
- [5] When populating boards in SMT production there are no unusual restrictions regarding the form of the pick and place nozzle except that mechanical essure on the surface of the resin must be avoided.
- [6] Please do not apply diagonal force to the silicone lens in excess of 3000gf or permanent and fatal damage will occur.
- [7] Please do not cover the silicone resin with any other resin (epoxy, urethane, etc)