

■Features

- High Luminous Super Flux Output
- Superior Weather-resistance
- UV Resistant Epoxy
- Long Lifetime Operation
- Water Clear Type

■Applications

- General Purpose Indicators
- Small Area Illuminations
- Back Lighting
- Other Lighting

■Outline Dimension

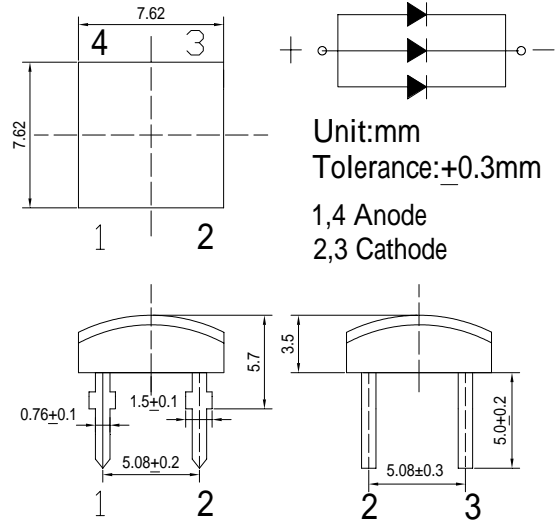

■Absolute Maximum Rating

(Ta=25)

Item	Symbol	Value	Unit
DC Forward Current	I _F	90	mA
Pulse Forward Current*	I _{FP}	360	mA
Reverse Voltage	V _R	5	V
Power Dissipation	P _D	324	mW
Operating Temperature	Topr	-30 ~ +85	
Storage Temperature	Tstg	-40 ~ +100	
Lead Soldering Temperature	Tsol	260 / 5sec	-

*Pulse width Max.10ms , Duty ratio max 1/10

■Directivity

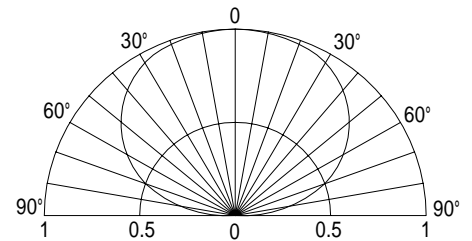

Electrical -Optical Characteristics

(Ta=25)

Item	Symbol	Condition	Min.	Typ.	Max.	Unit
DC Forward Voltage	V _F	I _F =90mA	2.9	3.1	3.6	V
DC Reverse Current	I _R	V _R =5V	-	-	30	μA
Luminous Flux*	v	I _F =90mA	35	40	-	lm
		I _F =60mA	24	27	-	
Color Temperature	CCT	I _F =90mA	-	6500	-	K
Chromaticity Coordinates*	x	I _F =90mA	-	0.31	-	
	y	I _F =90mA	-	0.33	-	
50% Power Angle	2θ _{1/2}	I _F =90mA	-	140	-	deg

*1 Tolerance of chromaticity coordinates is ±10%

*2 Tolerance of luminous intensity is ±15%