

■Features

- High Radiant Power LEDs
- 5mm Standard Directivity
- Superior Weather-resistance
- UV Resistant Epoxy
- Water Clear Type

■Applications

- IrDA
- Encoder
- Data Communication
- IR camera

■Outline Dimension

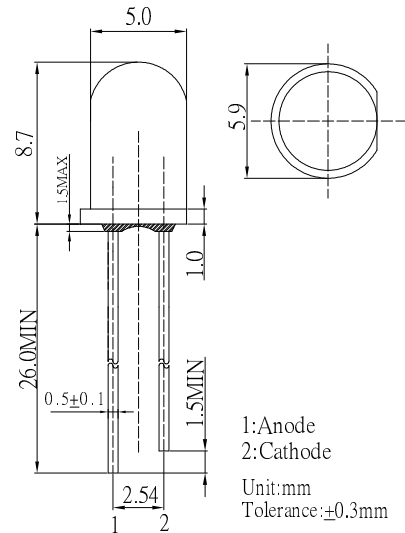

■Absolute Maximum Rating

(Ta=25°C)

Item	Symbol	Value	Unit
DC Forward Current	I _F	70	mA
Pulse Forward Current*	I _{FP}	700	mA
Reverse Voltage	V _R	5	V
Power Dissipation	P _D	126	mW
Operating Temperature	Topr	-30 ~ +85	°C
Storage Temperature	Tstg	-40~ +100	°C
Lead Soldering Temperature	Tsol	260°C/5sec	-

■Directivity

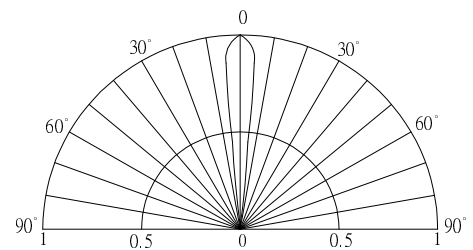

*Pulse width Max.10ms Duty ratio max 1/10

■Electrical -Optical Characteristics

(Ta=25°C)

Item	Symbol	Condition	Min.	Typ.	Max.	Unit
DC Forward Voltage	V _F	I _F =50mA	-	1.6	1.8	V
DC Reverse Current	I _R	V _R =5V	-	-	10	μA
Peak Wavelength	λ _p	I _F =50mA	-	850	-	nm
Radiant Intensity	I _e	I _F =50mA	-	45	-	mW/Sr
50% Power Angle	2θ _{1/2}	I _F =50mA	-	15	-	deg

*1 Tolerance of Peak wavelength is ±1nm

*2 Tolerance of luminous intensity is ±15%