

### Features

- High Luminous LEDs
- 5mm Round Standard Directivity
- Long Lifetime Operation (Up to 100,000 hours)
- Superior Weather-resistance
- UV Resistant Epoxy
- Water Clear Type

### Applications

- Electronic Signs And Signals
- Small Area Illuminations
- Back Lighting
- Other Lighting

### Outline Dimension

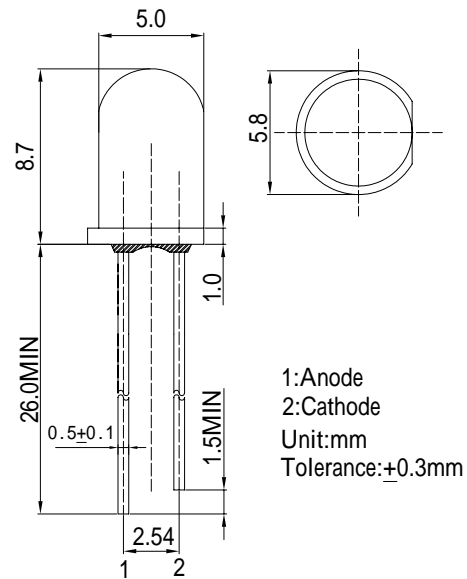

### Absolute Maximum Rating (Ta=25 °C)

Item	Symbol	Value	Unit
DC Forward Current	$I_F$	30	mA
Pulse Forward Current*	$I_{FP}$	100	mA
Reverse Voltage	$V_R$	5	V
Power Dissipation	$P_D$	108	mW
Operating Temperature	$T_{opr}$	-30 ~ +85	
Storage Temperature	$T_{stg}$	-40 ~ +100	
Lead Soldering Temperature	$T_{sol}$	260 /5sec	-

\*Pulse width Max 10ms , Duty ratio max 1/10

### Directivity

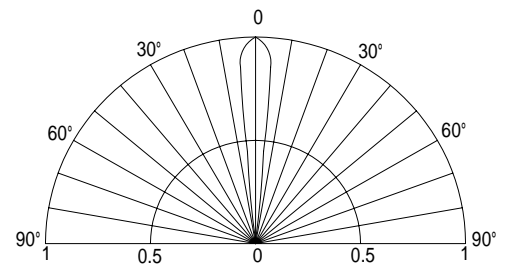

### Electrical -Optical Characteristics (Ta=25 °C)

Item	Symbol	Condition	Min.	Typ.	Max.	Unit
DC Forward Voltage	$V_F$	$I_F=20mA$	2.9	3.1	3.6	V
DC Reverse Current	$I_R$	$V_R=5V$	-	-	10	μA
Luminous Intensity*	$I_v$	$I_F=20mA$	18000	22000	-	mcd
Chromaticity Coordinates*	x	$I_F=20mA$	-	0.45	-	
	y	$I_F=20mA$	-	0.41	-	
50% Power Angle	$2\theta_{1/2}$	$I_F=20mA$	-	15	-	deg

\*1 Tolerance of chromaticity coordinates is ±10%

\*2 Tolerance of luminous intensity is ±15%