

# Approval Sheet

## (產品承認書)

產品名稱 (Product): BT 4.1 Module (Nordic nRF51822)

產品型號 (Model No.): MDBT40 Series & MDBT40-P Series

### Advantages of MDBT40 & MDBT40-P Series

1. Long Working Distance  
MDBT40 Series: Over 80 meters in open space  
MDBT40-P Series: Up to 60 meters in open space
2. Declaration ID already included all Nordic applied profiles.
3. Granted major regional certificates, including FCC, CE, TELECOM (Japanese), SRRC (China), IC (Canada), NCC (Taiwan)

# Index

<b>List of Raytac's Model No.</b> .....	<b>3</b>
<b>1. Overall Introduction</b> .....	<b>4</b>
1.1 Applications .....	4
1.2 Features .....	5
1.3 Profile & Service Information .....	6
<b>2. Product Dimension</b> .....	<b>7</b>
2.1 <b>MDBT40</b> Series .....	7
2.2 <b>MDBT40-P</b> Series .....	9
2.3 Pin Assignment .....	11
<b>3. Main Chip Solution</b> .....	<b>12</b>
<b>4. Shipment Packaging Information</b> .....	<b>13</b>
4.1 Marking on Metal Shielding .....	14
<b>5. Specification</b> .....	<b>15</b>
5.1 Industrial Temperature Range .....	15
5.2 Absolute Maximum Ratings .....	16
5.3 Operation Conditions .....	16
5.4 Electrical Specifications .....	17
<b>6. Block Diagram</b> .....	<b>23</b>
<b>7. Antenna</b> .....	<b>24</b>
7.1 <b>MDBT40</b> Series .....	24
7.2 <b>MDBT40-P</b> Series .....	26
<b>8. Reference Circuit</b> .....	<b>27</b>
8.1 nRF51822 Schematic with Internal LDO ( <b>Module's Default</b> ) .....	27
8.2 nRF51822 Schematic with 1.8V Low Voltage Mode .....	28
8.3 nRF51822 Schematic with Internal DC/DC Converter .....	29
<b>9. Carrier Keep-Out Area</b> .....	<b>30</b>
<b>10. Certification</b> .....	<b>31</b>
10.1 Declaration ID Certification .....	31
10.2 FCC Certification (USA) .....	32
10.3 TELEC Certification (Japanese) .....	34
10.4 NCC Certificate .....	35
10.5 CE Test Report (EU) .....	36
10.6 IC Certificate (Canada) .....	37
10.7 SRRC Certificate (China) .....	38
10.8 RoHS Report .....	39
10.9 Reliability Test .....	41
10.10 End-Product Label .....	43
<b>11. Current Consumption Reference Data (BT 3.0 VS BT 4.0)</b> .....	<b>45</b>
<b>12. BT 4.0 Product Certification Cost Comparison Chart</b> .....	<b>46</b>
<b>13. nRF51 IC Compatibility with SDK &amp; SoftDevice</b> .....	<b>47</b>
<b>Release Note</b> .....	<b>48</b>

# List of Raytac's Model No.

Series	Nordic Solution	Raytac No.	IC Version	Antenna	RAM	Flash Memory
MDBT40	nRF51822	MDBT40-128V3	3	Chip Antenna	16 kb	128 K
		MDBT40-256V3				256 K
		MDBT40-256RV3			32 kb	256 K
MDBT40-P	nRF51822	MDBT40-P128V3	3	PCB Antenna	16 kb	128 K
		MDBT40-P256V3				256 K
		MDBT40-P256RV3			32 kb	256 K
MDBT40 - ANT	nRF51422	MDBT40-ANT-256V3	3	Chip Antenna	16 kb	256 K
		MDBT40-ANT-256RV3			32 kb	
MDBT40 - ANT-P	nRF51422	MDBT40-ANT-P256V3	3	PCB Antenna	16 kb	256 K
		MDBT40-ANT-P256RV3			32 kb	
MDBT40 Nano	nRF51822	MDBT40-n256V3	3	N/A	16 kb	256 K
MDBT40 - ANT-Nano	nRF51422	MDBT40-ANT-n256V3	3	N/A	16 kb	256 K

# 1. Overall Introduction

Raytac's MDBT40 is a BT 4.0 & BT 4.1 stack (Bluetooth low energy or BLE) module designed based on **Nordic nRF51822 SoC solution**, which incorporates: **GPIO, UART, I2C, SPI, PWM** and **ADC interfaces** for connecting peripherals and sensors.

The feature of the module:

1. Dual Transmission Mode of BLE & RF 2.4G upon customer preference.
2. Compact size with **(L) 18 x (W) 10 x (H) 3.2 or 2.7 mm**
3. Low power requirements, ultra-low peak, average and idle mode power consumption.
4. Compatible with a large installed base of mobile phones, tablets and computers.
5. Fully coverage of BLE software stack including:  
Proximity Profile; Heart Rate Profile; Health Thermometer Profile;  
Blood Pressure Profile; Running Speed & Cadence Profile;  
HID Over GATT Profile; Alert Notification Profile; Glucose Profile;  
Cycling Speed & Cadence Profile
6. BLE & RF transmission switching may help products to fit all operation system
7. BLE & RF transmission switching may help products fit all kinds of hardware.

## 1.1 Applications

- . Computer peripherals and I/O devices
  - . Mouse
  - . Keyboard
  - . Multi-touch track pad
- . Interactive entertainment devices
  - . Remote control
  - . 3D Glasses
  - . Gaming controller
- . Personal Area Networks
  - . Health/fitness sensor and monitor devices
  - . Medical devices
  - . Key-fobs + wrist watch
  - . Remote control toys

## 1.2 Features

- . 2.4GHZ transceiver
  - . -93dbm sensitivity in Bluetooth low energy mode
  - . TX Power -20 to +4dbm
  - . RSSI (1db resolution)
- . ARM Cortex – M0 32 bit processor
  - . Serial Wire Debug (SWD)
- . S100 series SoftDevice ready
- . Memory
  - . 256kb or 128kb embedded flash programmed memory
  - . 16kb RAM or 32kb RAM
- . Support for non-concurrent multiprotocol operation
  - . On-air compatibility with nRF24L series
- . Flexible Power Management
  - . Supply voltage range 1.8V to 3.6V
  - . 2.5us wake-up using 16MHz RCOSC
  - . 0.6uA @ 3V mode
  - . 1.2uA @ 3V in OFF mode + 1 region RAM retention
  - . 2.6uA @ 3V ON mode, all blocks IDLE
- . 8/9/10 bit ADC- 8 configurable channels
- . 31 General Purpose I/O Pins
- . One 32 bit and two 16 bit timers with counter mode
- . SPI Master / Slave
- . Two-wire Master (I2C compatible)
- . UART (CTS/RTS)
- . CPU independent Programmable Peripheral Interconnect (PPI)
- . Quadrature Decoder (QDEC)
- . AES HW encryption
- . Real Timer Counter (RTC)

### 1.3 Profile & Service Information

Profile & Service below are supported by MDBT40.

<b>Profile Description</b>	<b>Service Description</b>
Alert Notification Profile	Alert Notification Service
Blood Pressure Profile	Blood Pressure Service
	Device Information Service
Cycling Speed & Cadence Profile	Cycling Speed & Cadence Service
	Device Information Service
Glucose Profile	Glucose Service
	Device Information Service
Health Thermometer Profile	Health Thermometer Service
	Device Information Service
Heart Rate Profile	Heart Rate Service
	Device Information Service
HID over GATT Profile	HID Service
	Battery Service
Proximity Profile	Link Loss Service
	Immediate Alert Service
	TX Power Service
Running Speed & Cadence Profile	Running Speed & Cadence Service
	Device Information Service

## 2. Product Dimension

### 2.1 **MDBT40** Series

#### PCB Dimensions, & Pin Indication & Layout Guide

PCB SIZE : (L) 18 x (W) 10 mm

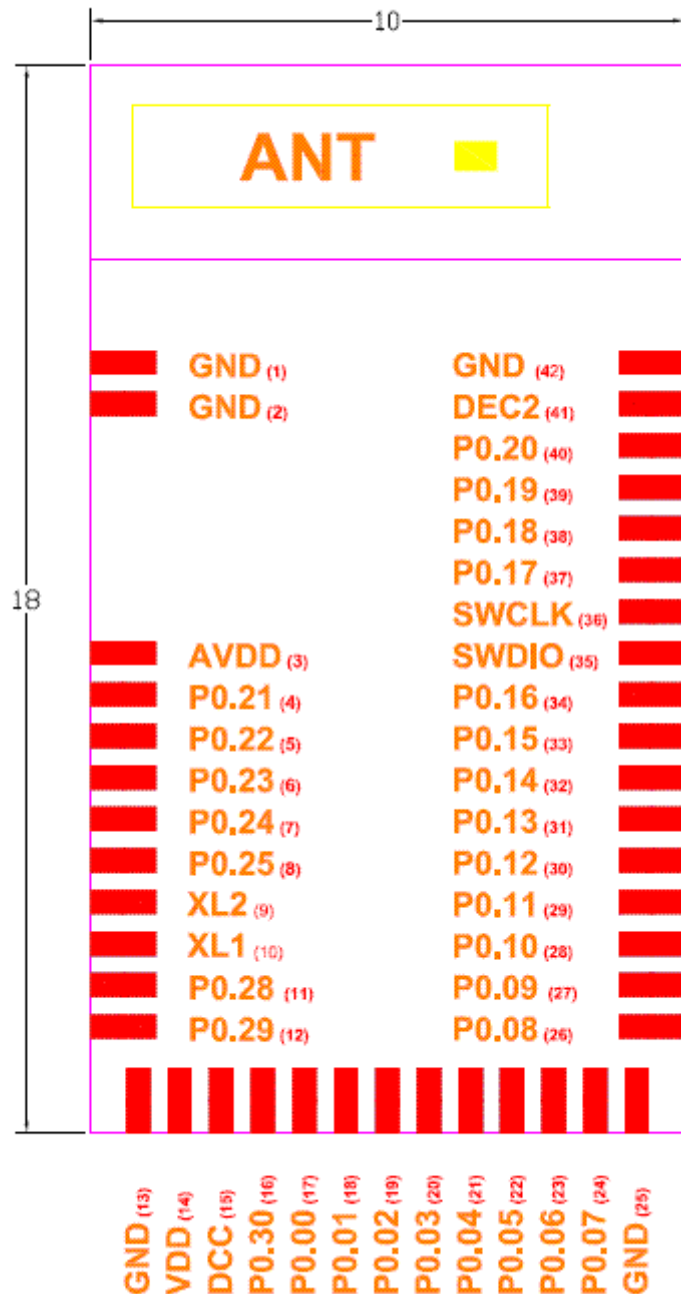
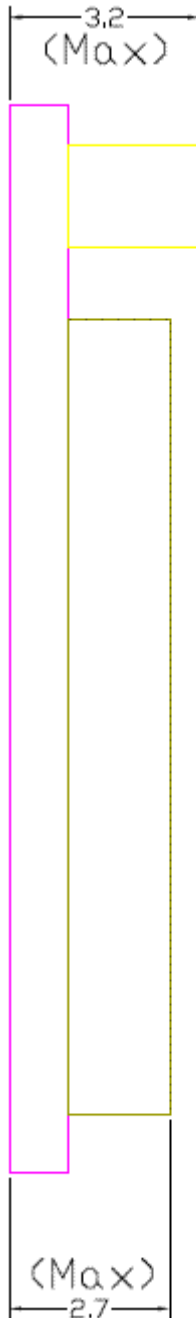

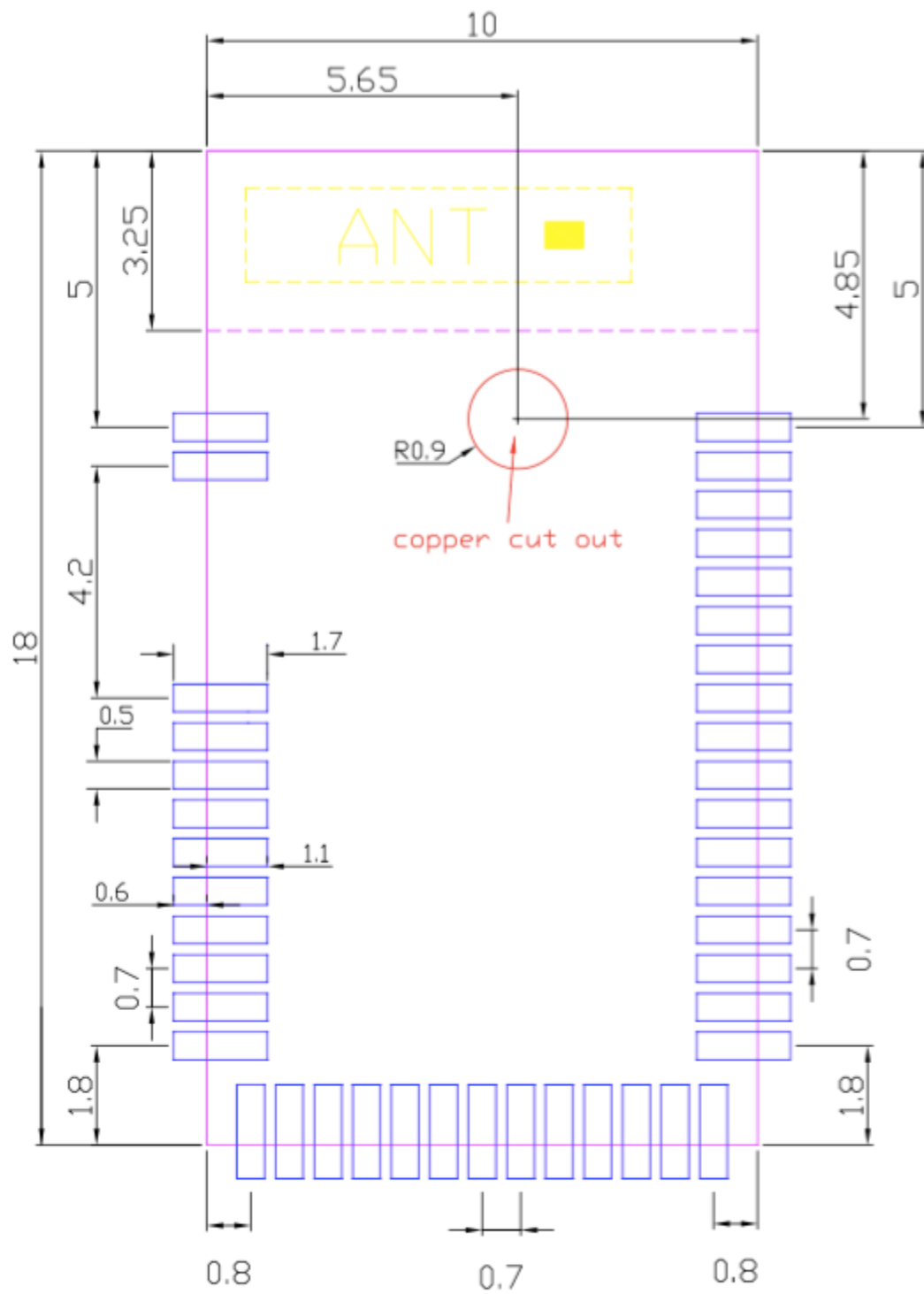



## 2.2 MDBT40-P Series

### PCB Dimensions, & Pin Indication & Layout Guide

PCB SIZE : (L) 18 x (W) 10 mm

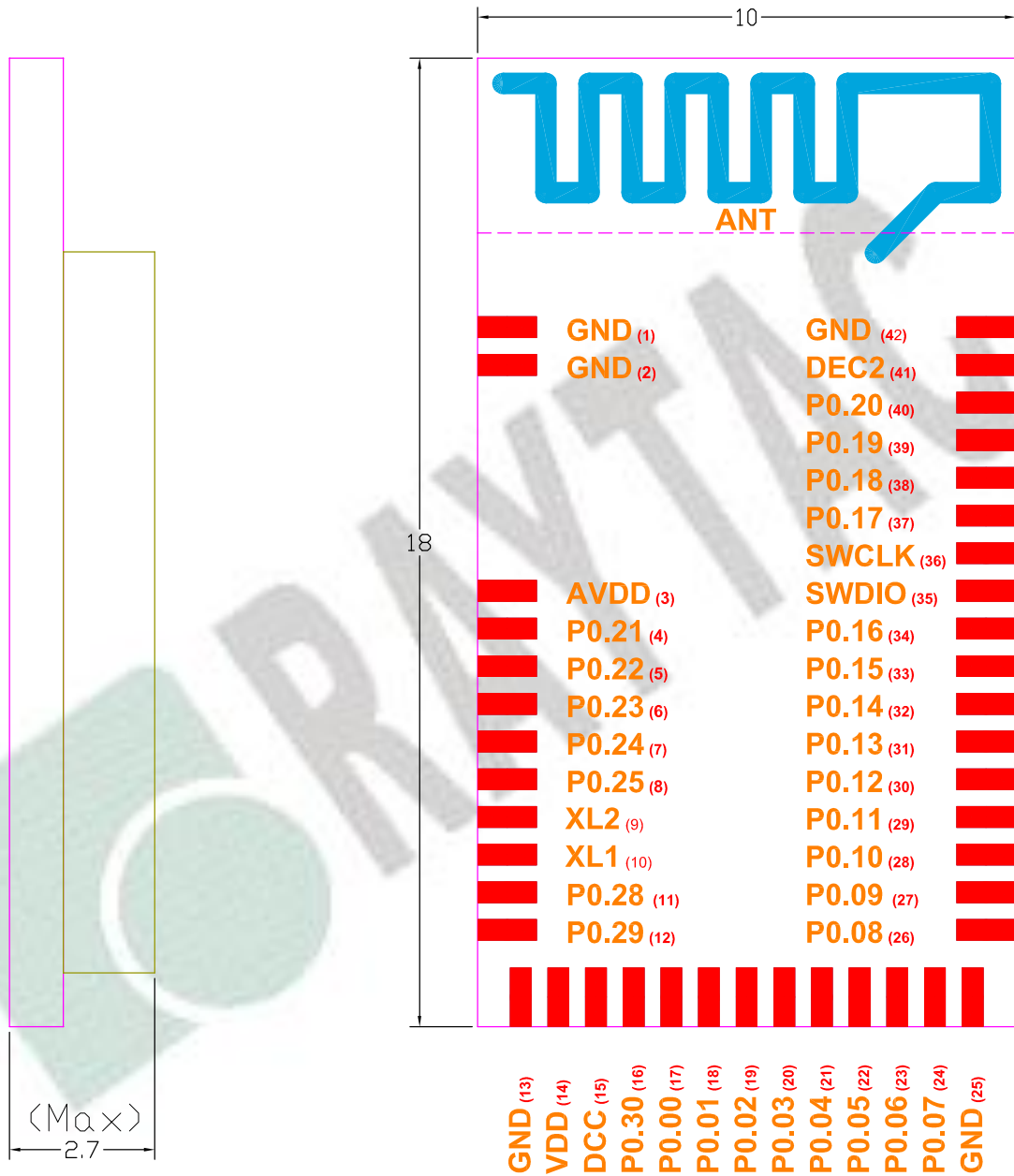

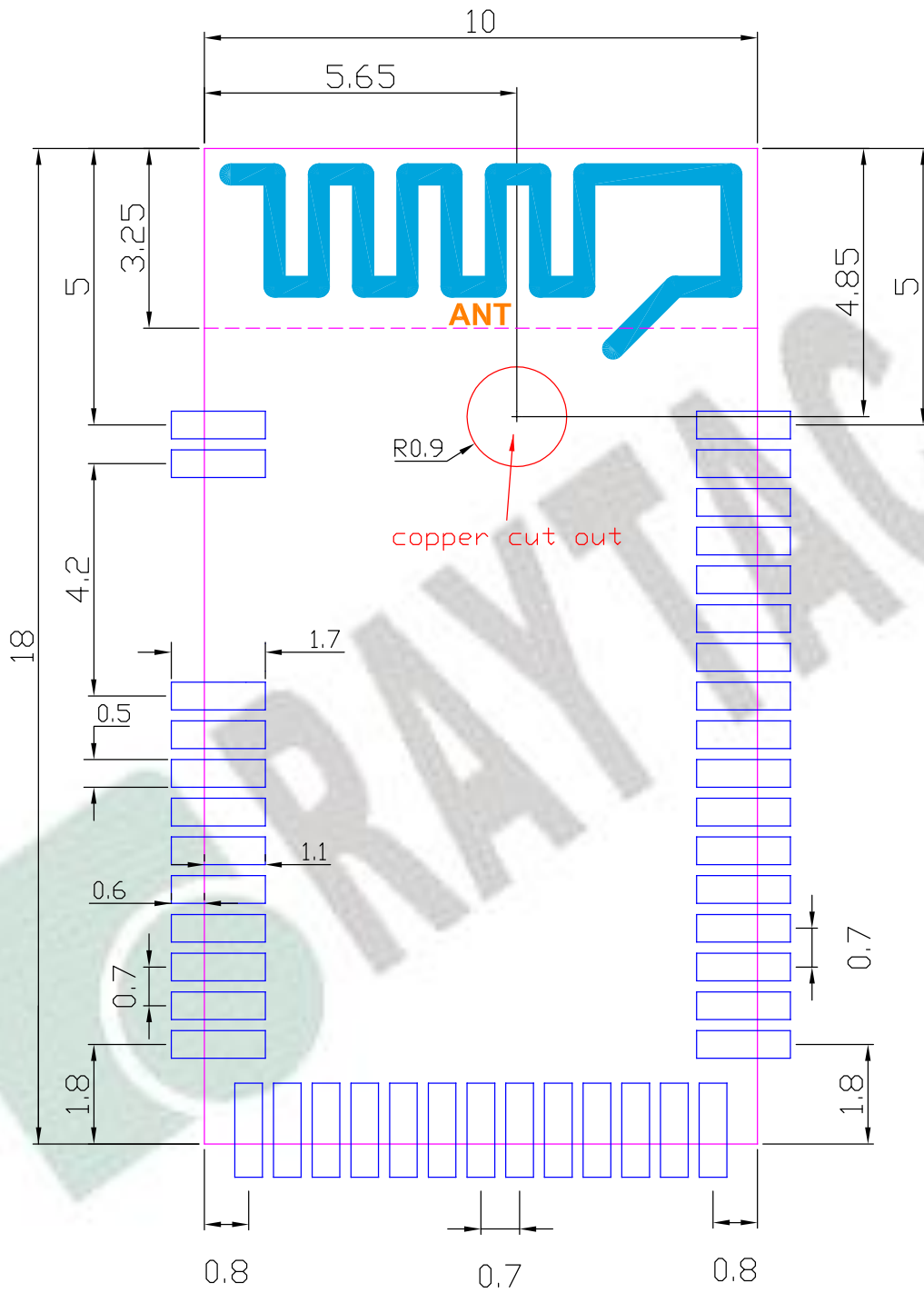

Top View (單位: mm)

recommended solder pad layout

## 2.3 Pin Assignment

Pin No.	Name	Pin function	Description
(1)(2)	<b>GND</b>	Ground	The pad must be connected to a solid ground plane
(3)	<b>AVDD</b>	Power	Analog power supply
(4)	<b>P0.21</b>	Digital I/O	General-purpose digital I/O
(5)	<b>P0.22</b>	Digital I/O	General-purpose digital I/O
(6)	<b>P0.23</b>	Digital I/O	General-purpose digital I/O
(7)	<b>P0.24</b>	Digital I/O	General-purpose digital I/O
(8)	<b>P0.25</b>	Digital I/O	General-purpose digital I/O
(9)	<b>P0.26</b>	Digital I/O	General-purpose digital I/O
	<b>AIN0</b>	Analog input	ADC input 0
	<b>XL2</b>	Analog output	Connector for 32.768KHz crystal
(10)	<b>P0.27</b>	Digital I/O	General-purpose digital I/O
	<b>AIN1</b>	Analog input	ADC input 1
	<b>XL1</b>	Analog input	Connector for 32.768KHz crystal or external 32.768KHz clock reference
(11)	<b>P0.28</b>	Digital I/O	General-purpose digital I/O
(12)	<b>P0.29</b>	Digital I/O	General-purpose digital I/O
(13)	<b>GND</b>	Ground	The pad must be connected to a solid ground plane
(14)	<b>VDD</b>	Power	Power supply
(15)	<b>DCC</b>	Power	DC/DC output voltage to external LC filter
(16)	<b>P0.30</b>	Digital I/O	General-purpose digital I/O
(17)	<b>P0.00</b>	Digital I/O	General-purpose digital I/O
	<b>AREF0</b>	Analog input	ADC Reference voltage
(18)	<b>P0.01</b>	Digital I/O	General-purpose digital I/O
	<b>AIN2</b>	Analog input	ADC input 2
(19)	<b>P0.02</b>	Digital I/O	General-purpose digital I/O
	<b>AIN3</b>	Analog input	ADC input 3
(20)	<b>P0.03</b>	Digital I/O	General-purpose digital I/O
	<b>AIN4</b>	Analog input	ADC input 4
(21)	<b>P0.04</b>	Digital Input	General-purpose digital I/O
	<b>AIN5</b>	Analog input	ADC input 5
(22)	<b>P0.05</b>	Digital I/O	General-purpose digital I/O
	<b>AIN6</b>	Analog input	ADC input 6

Pin No.	Name	Pin function	Description
(23)	P0.06	Digital I/O	General-purpose digital I/O
	AIN7	Analog input	ADC input 7
	AREF1	Analog input	ADC Reference voltage
(24)	P0.07	Digital I/O	General-purpose digital I/O
(25)	GND	Ground	The pad must be connected to a solid ground plane
(26)	P0.08	Digital I/O	General-purpose digital I/O
(27)	P0.09	Digital I/O	General-purpose digital I/O
(28)	P0.10	Digital I/O	General-purpose digital I/O
(29)	P0.11	Digital I/O	General-purpose digital I/O
(30)	P0.12	Digital I/O	General-purpose digital I/O
(31)	P0.13	Digital I/O	General-purpose digital I/O
(32)	P0.14	Digital I/O	General-purpose digital I/O
(33)	P0.15	Digital I/O	General-purpose digital I/O
(34)	P0.16	Digital I/O	General-purpose digital I/O
(35)	SWDIO/RESET	Digital I/O	System reset(active low).Also HW debug and flash Programming
(36)	SWDCLK	Digital input	HW debug and flash programming.
(37)	P0.17	Digital I/O	General-purpose digital I/O
(38)	P0.18	Digital I/O	General-purpose digital I/O
(39)	P0.19	Digital I/O	General-purpose digital I/O
(40)	P0.20	Digital I/O	General-purpose digital I/O
(41)	DEC2	Power	Power supply decoupling. Low voltage mode VCC
(42)	GND	Ground	The pad must be connected to a solid ground plane

<sup>1</sup> Digital I/O pad with 5mA source/sink capability.

### 3. Main Chip Solution

RF IC	Crystal Frequency
Nordic NRF51822/QFN48	16MHZ

## 4. Shipment Packaging Information

Marking	Model	
Black	MDBT40-128V3	MDBT40-P128V3
		
Red	MDBT40-256V3	MDBT40-P256V3
		
Yellow	MDBT40-256RV3	MDBT40-P256RV3
		



- Packaging Type: Tray only
- Minimum Package Quantity (MPQ): 88 pcs per Tray
- Carton Contents: 1760 pcs per Carton (20 Full Tray + 1 Empty Tray)
- Dimension of Carton: (L) 37 x (W) 21 x (H) 14 cm
- Gross Weight: approx. 3.2 kgs



**Remark: Packaging may be subject to change without further notice.**

## 4.1 Marking on Metal Shielding

To obey the regulation that we have granted, the marking contains following contents.

Raytac Corporation  
FCC ID: SH6MDBT40  
IC: 8017A-MDBT40  
CMIIT ID: 2015DJ2435  
Model No.: MDBT40  
  204-420020



## 5. Specification

### 5.1 Industrial Temperature Range

Industrial temperature range is applied in below IC chip.

nRF51822 variant	Build code
QFAA	Hx0 <sup>1</sup>
CEAA	Ex0 <sup>1</sup>

Raytac's corresponding model no. are **MDBT40-256V3**, **MDBT40-P256V3** and **MDBT40-n256V3**.

Operating conditions are as below:

Symbol	Parameter	Notes	Min.	Typ.	Max.	Units
VDD	Supply voltage, internal LDO setup		1.9	3.0	3.6	V
VDD	Supply voltage, DC/DC converter setup		2.1	3.0	3.6	V
T <sub>A</sub>	Operating temperature		-40	25	105	°C

Other changes are including:

- (1) 2.4Ghz transceiver: Not supported 1Mbps data rates
- (2) Not support 1.8V low voltage mode

For detail of changes, please refer to Nordic's document "nRF51822\_PSA\_EXTEMP\_v1.0". Any updates shall refer to Nordic's release as final reference.

**Except for MDBT40-256V3, MDBT40-P256V3 and MDBT40-n256V3, please check remaining section of Chapter 5 to know specification of other models.**

## 5.2 Absolute Maximum Ratings

Symbol	Parameter	Min.	Max.	Unit
<b>Supply voltages</b>				
VDD		-0.3	+3.9	V
DEC2			2	V
VSS			0	V
<b>I/O pin voltage</b>				
VIO		-0.3	VDD + 0.3	V
<b>Environmental QFN48 package</b>				
Storage temperature		-40	+125	°C
MSL	Moisture Sensitivity Level		2	
ESD HBM	Human Body Model		4	kV
ESD CDM	Charged Device Model		750	V
<b>Environmental WLCSP package</b>				
Storage temperature		-40	+125	°C
MSL	Moisture Sensitivity Level		1	
ESD HBM	Human Body Model		4	kV
ESD CDM	Charged Device Model		500	V
<b>Flash memory</b>				
Endurance		20 000 <sup>1</sup>		write/erase cycles
Retention		10 years at 40 °C		
Number of times an address can be written between erase cycles			2	times

## 5.3 Operation Conditions

Symbol	Parameter	Notes	Min.	Typ.	Max.	Units
VDD	Supply voltage, internal LDO setup		1.8	3.0	3.6	V
VDD	Supply voltage, DC/DC converter setup		2.1	3.0	3.6	V
VDD	Supply voltage, low voltage mode setup	1	1.75	1.8	1.95	V
t <sub>R_VDD</sub>	Supply rise time (0 V to VDD)	2			100	ms
T <sub>A</sub>	Operating temperature		-25	25	75	°C

1. DEC2 shall be connected to VDD in this mode.
2. The on-chip power-on reset circuitry may not function properly for rise times outside the specified interval.



## 5.4 Electrical Specifications

### 5.3.1 Radio Transceiver

#### . General Radio Characteristics

Symbol	Description	Note	Min.	Typ.	Max.	Units	Test level
$f_{OP}$	Operating frequencies.	1 MHz channel spacing.	2400		2483	MHz	N/A
$PLL_{res}$	PLL programming resolution.			1		MHz	N/A
$\Delta f_{250}$	Frequency deviation at 250 kbps.			$\pm 170$		kHz	2
$\Delta f_{1M}$	Frequency deviation at 1 Mbps.			$\pm 170$		kHz	2
$\Delta f_{2M}$	Frequency deviation at 2 Mbps.			$\pm 320$		kHz	2
$\Delta f_{BLE}$	Frequency deviation at BLE.		$\pm 225$	$\pm 250$	$\pm 275$	kHz	4
$bps_{FSK}$	On-air data rate.		250		2000	kbps	N/A

#### . Radio Current Consumption

Symbol	Description	Note	Min.	Typ.	Max.	Units	Test level
$I_{TX,+4dBm}$	TX only run current at $P_{OUT} = +4$ dBm.	1		16		mA	4
$I_{TX,0dBm}$	TX only run current at $P_{OUT} = 0$ dBm.	1		10.5		mA	4
$I_{TX,-4dBm}$	TX only run current at $P_{OUT} = -4$ dBm.	1		8		mA	2
$I_{TX,-8dBm}$	TX only run current at $P_{OUT} = -8$ dBm.	1		7		mA	2
$I_{TX,-12dBm}$	TX only run current at $P_{OUT} = -12$ dBm.	1		6.5		mA	2
$I_{TX,-16dBm}$	TX only run current at $P_{OUT} = -16$ dBm.	1		6		mA	2
$I_{TX,-20dBm}$	TX only run current at $P_{OUT} = -20$ dBm.	1		5.5		mA	2
$I_{TX,-30dBm}$	TX only run current at $P_{OUT} = -30$ dBm.	1		5.5		mA	2
$I_{START,TX}$	TX startup current.	2		7		mA	1
$I_{RX,250}$	RX only run current at 250 kbps.			12.6		mA	1
$I_{RX,1M}$	RX only run current at 1 Mbps.			13		mA	4
$I_{RX,2M}$	RX only run current at 2 Mbps.			13.4		mA	1
$I_{START,RX}$	RX startup current.	3		8.7		mA	1

1. Valid for data rates 250 kbps, 1 Mbps, and 2 Mbps.
2. Average current consumption (at 0 dBm TX output power) for TX startup (130  $\mu$ s), and when changing mode from RX to TX (130  $\mu$ s).
3. Average current consumption for RX startup (130  $\mu$ s), and when changing mode from TX to RX (130  $\mu$ s).

### 5.3.2. Transmitter Specifications

Symbol	Description	Min.	Typ.	Max.	Units	Test level
$P_{RF}$	Maximum output power.		4		dBm	4
$P_{RFC}$	RF power control range.	20	24		dB	2
PRFCR	RF power accuracy.			$\pm 4$	dB	1
$P_{WHISP}$	RF power whisper mode.		-30		dBm	2
$P_{BW2}$	20 dB bandwidth for modulated carrier (2 Mbps).		1800	2000	kHz	2
$P_{BW1}$	20 dB bandwidth for modulated carrier (1 Mbps).		950	1100	kHz	2
$P_{BW250}$	20 dB bandwidth for modulated carrier (250 kbps).		700	800	kHz	2
$P_{RF1.2}$	1 <sup>st</sup> Adjacent Channel Transmit Power. $\pm 2$ MHz (2 Mbps).			-20	dBc	2
$P_{RF2.2}$	2 <sup>nd</sup> Adjacent Channel Transmit Power. $\pm 4$ MHz (2 Mbps).			-45	dBc	2
$P_{RF1.1}$	1 <sup>st</sup> Adjacent Channel Transmit Power. $\pm 1$ MHz (1 Mbps).			-20	dBc	2
$P_{RF2.1}$	2 <sup>nd</sup> Adjacent Channel Transmit Power. $\pm 2$ MHz (1 Mbps).			-40	dBc	2
$P_{RF1.250}$	1 <sup>st</sup> Adjacent Channel Transmit Power. $\pm 1$ MHz (250 kbps).			-25	dBc	2
$P_{RF2.250}$	2 <sup>nd</sup> Adjacent Channel Transmit Power. $\pm 2$ MHz (250 kbps).			-40	dBc	2
$t_{TX,30}$	Maximum consecutive transmission time, $f_{TOL} < \pm 30$ ppm.			16	ms	1
$t_{TX,60}$	Maximum consecutive transmission time, $f_{TOL} < \pm 60$ ppm.			4	ms	1

### 5.3.3 Receiver Specifications

Symbol	Description	Min.	Typ.	Max.	Units	Test level
<b>Receiver operation</b>						
PRX <sub>MAX</sub>	Maximum received signal strength at < 0.1% PER.		0		dBm	1
PRX <sub>SENS,2M</sub>	Sensitivity (0.1% BER) at 2 Mbps.		-85		dBm	2
PRX <sub>SENS,1M</sub>	Sensitivity (0.1% BER) at 1 Mbps.		-90		dBm	2
PRX <sub>SENS,250k</sub>	Sensitivity (0.1% BER) at 250 kbps.		-96		dBm	2
P <sub>SENS IT</sub> 1 Mbps BLE	Receiver sensitivity: Ideal transmitter.		-93		dBm	2
P <sub>SENS DT</sub> 1 Mbps BLE	Receiver sensitivity: Dirty transmitter. <sup>1</sup>		-91		dBm	2
<b>RX selectivity - modulated interfering signal<sup>2</sup></b>						
<b>2 Mbps</b>						
C/I <sub>CO</sub>	C/I co-channel.		12		dB	2
C/I <sub>1ST</sub>	1 <sup>st</sup> ACS, C/I 2 MHz.		-4		dB	2
C/I <sub>2ND</sub>	2 <sup>nd</sup> ACS, C/I 4 MHz.		-24		dB	2
C/I <sub>3RD</sub>	3 <sup>rd</sup> ACS, C/I 6 MHz.		-28		dB	2
C/I <sub>6th</sub>	6 <sup>th</sup> ACS, C/I 12 MHz.		-44		dB	2
C/I <sub>Nth</sub>	N <sup>th</sup> ACS, C/I f <sub>i</sub> > 25 MHz.		-50		dB	2
<b>1 Mbps</b>						
C/I <sub>CO</sub>	C/I co-channel (1 Mbps).		12		dB	2
C/I <sub>1ST</sub>	1 <sup>st</sup> ACS, C/I 1 MHz.		4		dB	2
C/I <sub>2ND</sub>	2 <sup>nd</sup> ACS, C/I 2 MHz.		-24		dB	2
C/I <sub>3RD</sub>	3 <sup>rd</sup> ACS, C/I 3 MHz.		-30		dB	2
C/I <sub>6th</sub>	6 <sup>th</sup> ACS, C/I 6 MHz.		-40		dB	2
C/I <sub>12th</sub>	12 <sup>th</sup> ACS, C/I 12 MHz.		-50		dB	2
C/I <sub>Nth</sub>	N <sup>th</sup> ACS, C/I f <sub>i</sub> > 25 MHz.		-53		dB	2

Symbol	Description	Min.	Typ.	Max.	Units	Test level
<b>250 kbps</b>						
C/I <sub>CO</sub>	C/I co-channel.		4		dB	2
C/I <sub>1ST</sub>	1 <sup>st</sup> ACS, C/I 1 MHz.		-10		dB	2
C/I <sub>2ND</sub>	2 <sup>nd</sup> ACS, C/I 2 MHz.		-34		dB	2
C/I <sub>3RD</sub>	3 <sup>rd</sup> ACS, C/I 3 MHz.		-39		dB	2
C/I <sub>6th</sub>	6 <sup>th</sup> ACS, C/I $f_i > 6$ MHz.		-50		dB	2
C/I <sub>12th</sub>	12 <sup>th</sup> ACS, C/I 12 MHz.		-55		dB	2
C/I <sub>Nth</sub>	N <sup>th</sup> ACS, C/I $f_i > 25$ MHz.		-60		dB	2
<b>Bluetooth Low Energy RX selectivity</b>						
C/I <sub>CO</sub>	C/I co-channel.		10		dB	2
C/I <sub>1ST</sub>	1 <sup>st</sup> ACS, C/I 1 MHz.		1		dB	2
C/I <sub>2ND</sub>	2 <sup>nd</sup> ACS, C/I 2 MHz.		-25		dB	2
C/I <sub>3+N</sub>	ACS, C/I (3+n) MHz offset [n = 0, 1, 2, ...].		-51		dB	2
C/I <sub>Image</sub>	Image blocking level.		-30		dB	2
C/I <sub>Image±1MHz</sub>	Adjacent channel to image blocking level (±1 MHz).		-31		dB	2
<b>RX intermodulation<sup>3</sup></b>						
P_IMD <sub>2Mbps</sub>	IMD performance, 2 Mbps, 3rd, 4th, and 5th offset channel.		-41		dBm	2
P_IMD <sub>1Mbps</sub>	IMD performance, 1 Mbps, 3rd, 4th, and 5th offset channel.		-40		dBm	2
P_IMD <sub>250kbps</sub>	IMD performance, 250 kbps, 3rd, 4th, and 5th offset channel.		-36		dBm	2
P_IMD <sub>BLE</sub>	IMD performance, 1 Mbps BLE, 3rd, 4th, and 5th offset channel.		-39		dBm	2

1. As defined in the *Bluetooth Core Specification v4.0 Volume 6: Core System Package (Low Energy Controller Volume)*.
2. Wanted signal level at  $P_{IN} = -67$  dBm. One interferer is used, having equal modulation as the wanted signal. The input power of the interferer where the sensitivity equals BER = 0.1% is presented.
3. Wanted signal level at  $P_{IN} = -64$  dBm. Two interferers with equal input power are used. The interferer closest in frequency is not modulated, the other interferer is modulated equal with the wanted signal. The input power of interferers where the sensitivity equals BER = 0.1% is presented.

### 5.3.4 Radio Timing Parameters

Symbol	Description	250 k	1 M	2 M	BLE	Jitter	Units
$t_{TXEN}$	Time between TXEN task and READY event.	132	132	132	140	0	$\mu s$
$t_{TXDISABLE}$	Time between DISABLE task and DISABLED event when the radio was in TX.	10	4	3	4	1	$\mu s$
$t_{RXEN}$	Time between the RXEN task and READY event.	130	130	130	138	0	$\mu s$
$t_{RXDISABLE}$	Time between DISABLE task and DISABLED event when the radio was in RX.	0	0	0	0	1	$\mu s$
$t_{TXCHAIN}$	TX chain delay.	5	1	0.5	1	0	$\mu s$
$t_{RXCHAIN}$	RX chain delay.	12.5	3	2	3	0	$\mu s$

### 5.3.5 RSSI Specifications

Symbol	Description	Note	Min.	Typ.	Max.	Units	Test level
$RSSI_{ACC}$	RSSI accuracy.	Valid range -50 dBm to -80 dBm.			$\pm 6$	dB	2
$RSSI_{RESOLUTION}$	RSSI resolution.			1		dB	1
$RSSI_{PERIOD}$	Sample period.		8.8			$\mu s$	1
$RSSI_{CURRENT}$	Current consumption in addition to $I_{RX}$ .			250		$\mu A$	1

### 5.3.6 CPU

Symbol	Description	Min.	Typ.	Max.	Units	Test level
$I_{CPU, FLASH}$	Run current at 16 MHz (XOSC). Executing code from flash memory.		4.1 <sup>1</sup>		mA	2
$I_{CPU, RAM}$	Run current at 16 MHz (XOSC). Executing code from RAM.		2.4 <sup>2</sup>		mA	1
$I_{START, CPU}$	CPU startup current.		600		$\mu A$	1
$t_{START, CPU}$	IDLE to CPU execute.	0 <sup>3</sup>			$\mu s$	1

1. Includes CPU, flash, 1V2, 1V7, RC16M.
2. Includes CPU, RAM, 1V2, RC16M.
3.  $t_{1V2}$  if 1V2 regulator is not running already.

## 5.3.7 Power Management

Symbol	Description	Note	Min.	Typ.	Max.	Units	Test level
$I_{OFF}$	Current in SYSTEM OFF, no RAM retention.			0.6 <sup>1</sup>		μA	2
$I_{OFF,RET,8k}$	Additional current in SYSTEM OFF per retained RAM block (8 kB)			0.6 <sup>1</sup>		μA	2
$I_{OFF2ON}$	OFF to CPU execute transition current.			400		μA	1
$t_{OFF2ON}$	OFF to CPU execute.			9.6	10.6	μs	1
$I_{ON,16k}$	SYSTEM-ON base current with 16 kB RAM enabled.			2.6 <sup>1</sup>		μA	2
$I_{ON,32k}$	SYSTEM-ON base current with 32 kB RAM enabled.			3.8 <sup>1</sup>		μA	2
$t_{1V2}$	Startup time for 1V2 regulator.			2.3		μs	1
$I_{1V2XO16}$	Current drawn by 1V2 regulator and 16 MHz XOSC when both are on at the same time.	See Table 33 on page 48.		810 <sup>2</sup>		μA	1
$I_{1V2XO32}$	Current drawn by 1V2 regulator and 32 MHz XOSC when both are on at the same time.	See Table 33 on page 48.		840 <sup>2</sup>		μA	1
$I_{1V2RC16}$	Current drawn by 1V2 regulator and 16 MHz RCOSC when both are on at the same time.	See Table 33 on page 48.		880 <sup>2</sup>		μA	1
$I_{1V2XO16,1M}$	For HFCLK in 1 MHz mode <sup>3</sup> . Current drawn by 1V2 regulator and 16 MHz XOSC when both are on at the same time.	See Table 33 on page 48.		520 <sup>2</sup>		μA	1
$I_{1V2XO32,1M}$	For HFCLK in 1 MHz mode <sup>3</sup> . Current drawn by 1V2 regulator and 32 MHz XOSC when both are on at the same time.	See Table 33 on page 48.		560 <sup>2</sup>		μA	1
$I_{1V2RC16,1M}$	For HFCLK in 1 MHz mode <sup>3</sup> . Current drawn by 1V2 regulator and 16 MHz RCOSC when both are on at the same time.	See Table 33 on page 48.		630 <sup>2</sup>		μA	1
$t_{XO}$	Startup time for the clock management system when the XTAL is in standby.			2.3	5.3	μs	1

Symbol	Description	Note	Min.	Typ.	Max.	Units	Test level
$t_{1V7}$	Startup time for 1V7 regulator			2	3.6	μs	1
$I_{1V7}$	Current drawn by 1V7 regulator			105		μA	2
$F_{DCDC}$	DC/DC converter current conversion factor.		0.65 <sup>4</sup>		1.2 <sup>4</sup>		1

1. Add 1 μA to the current value if the device is used in Low voltage mode.
2. This number includes the current used by the automated power and clock management system.
3. For details on 1 MHz mode, see Section 4.2 “Timer/counters (TIMER)” on page 32.
4.  $F_{DCDC}$  will vary depending on VDD and internal radio current consumption ( $I_{DD}$ ). Please refer to the *nRF51 Series Reference Manual*, v3.0 or later, for a method to calculate  $I_{DD,DCDC}$ . See Figure 11 on page 50 for a DC/DC conversion factor chart.

# 6. Block Diagram

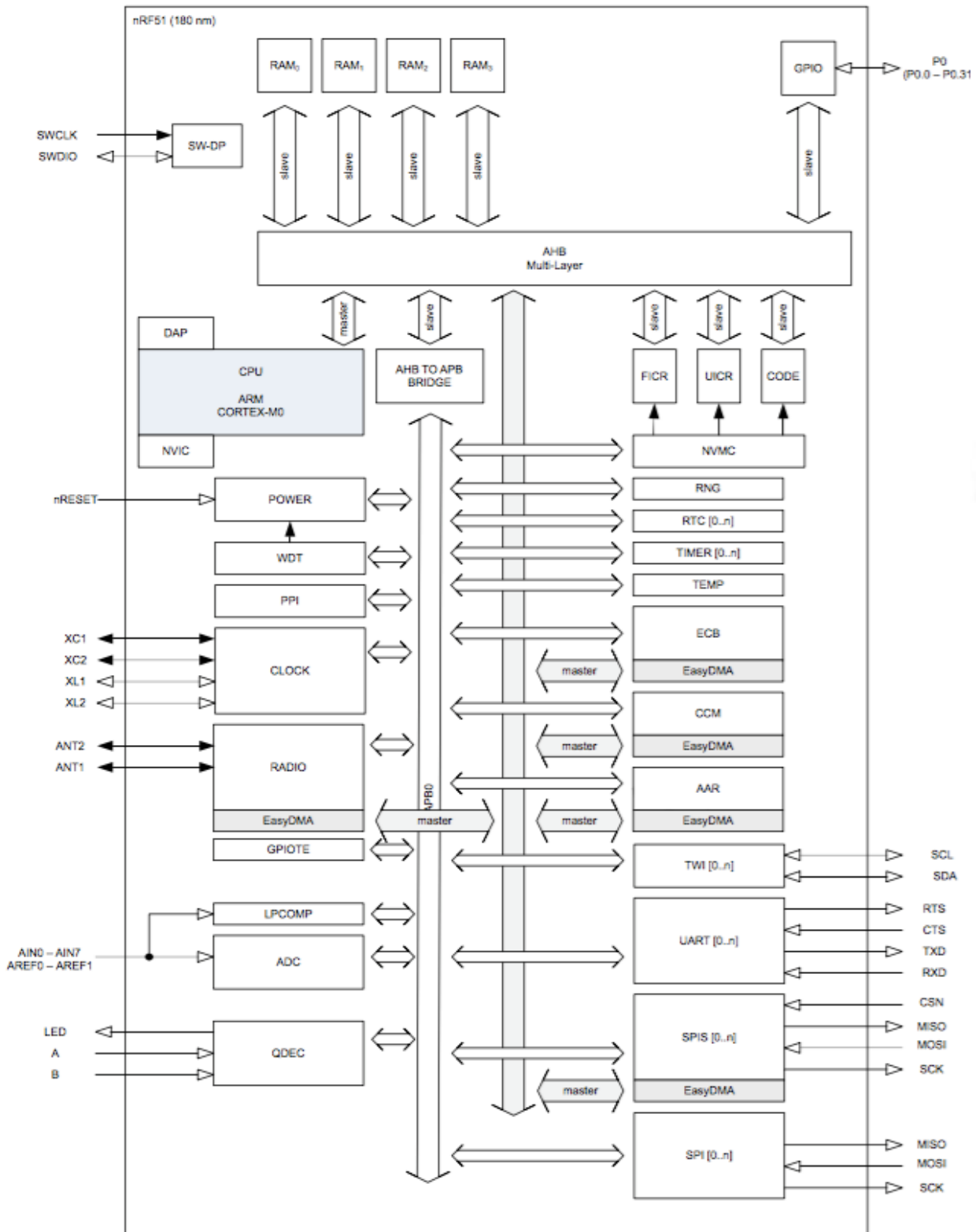

nRF51822 block diagram

# 7. Antenna

## 7.1 MDBT40 Series



### AT7020 Series Multilayer Chip Antenna

#### Features

- ❖ Monolithic SMD with small, low-profile and light-weight type.
- ❖ Wide bandwidth

#### Applications

- ❖ 2.4GHz WLAN, Home RF, Bluetooth Modules, etc.



#### Specifications

Part Number	Frequency Range (MHz)	Peak Gain (dBi typ.)	Average Gain (dBi typ.)	VSWR	Impedance
<b>AT7020</b> <b>-E3R0HBA_</b>	2400~2500	1.3dBi (XZ-V)	-0.5dBi (XZ-V)	2 max.	50 Ω

- ❖ Return Loss/With Matching Circuits

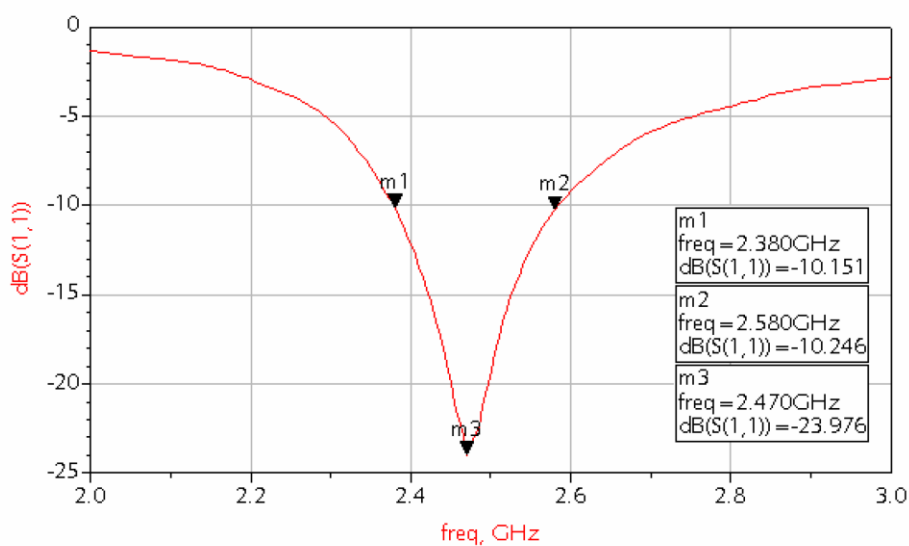



❖ Radiation Patterns

XY-V/XY-H

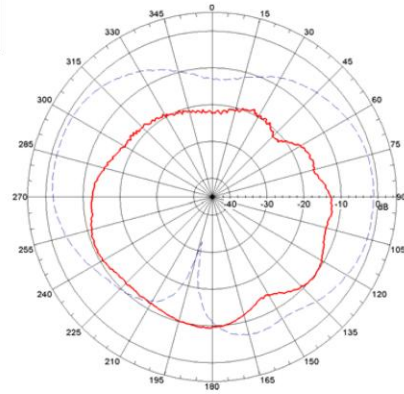
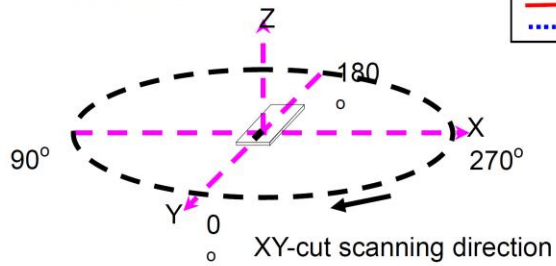

XZ-V/XZ-H

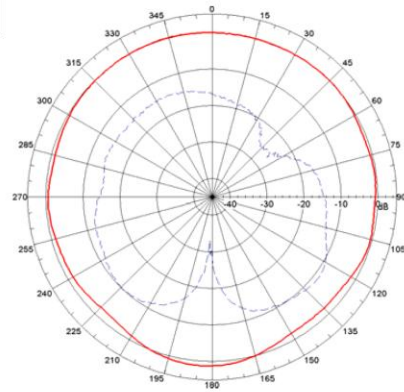
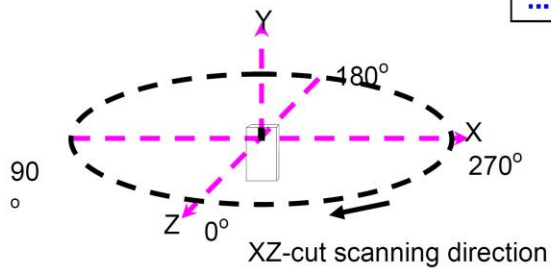

YZ-V/YZ-H

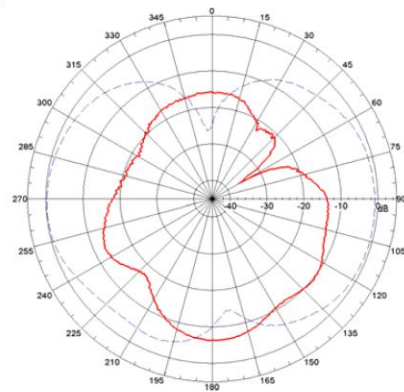
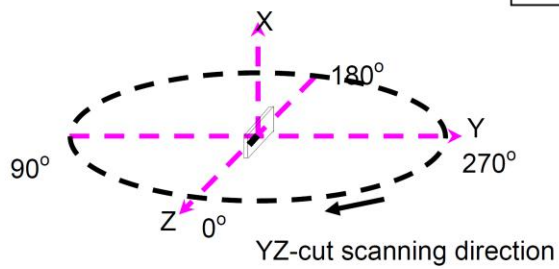

## 7.2 MDBT40-P Series

**Antenna Manufacturer : Raytac Corporation.**

**MODEL:Printed Trace Antenna**

C. X-Z polarization scan

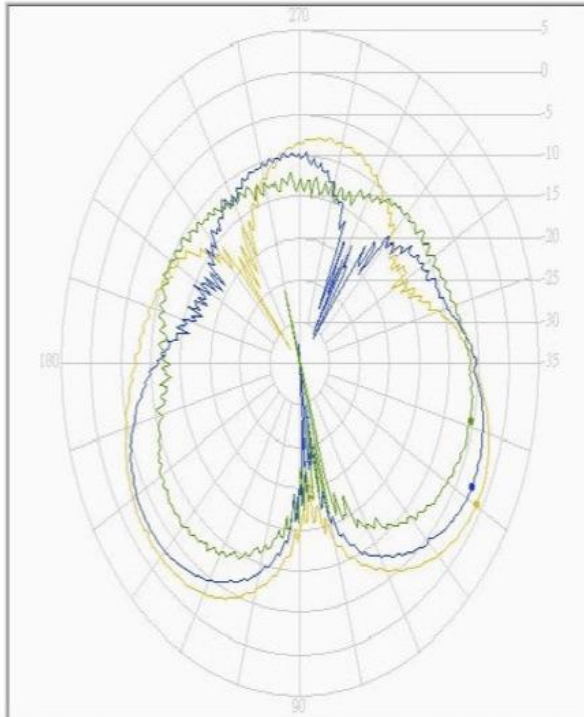

Model No.	Ant. Polarization	Freq(MHz)	Peak angle	Value	Average
XZ 2400 H	Horizontal	2400.0	330.3	-0.9	-6.1
XZ 2450 H	Horizontal	2450.0	332.8	-2.5	-7.6
XZ 2500 H	Horizontal	2500.0	346.0	-5.5	-9.8

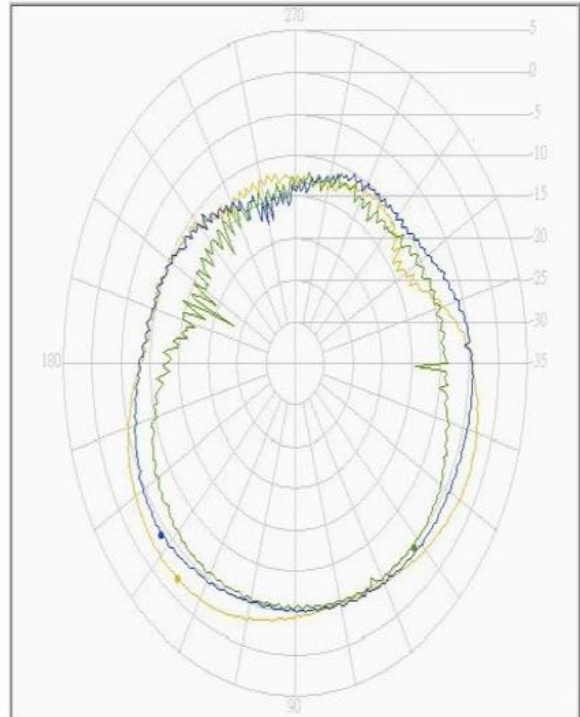

Model No.	Ant. Polarization	Freq(MHz)	Peak angle	Value	Average
XZ 2400 V	Vertical	2400.0	232.1	-2.0	-5.7
XZ 2450 V	Vertical	2450.0	221.8	-4.1	-6.6
XZ 2500 V	Vertical	2500.0	312.7	-4.8	-8.5

## 8. Reference Circuit

### 8.1 nRF51822 Schematic with Internal LDO (Module's Default)

Default is using external 32.768kHz crystal. Please make sure it is connected to make module work.

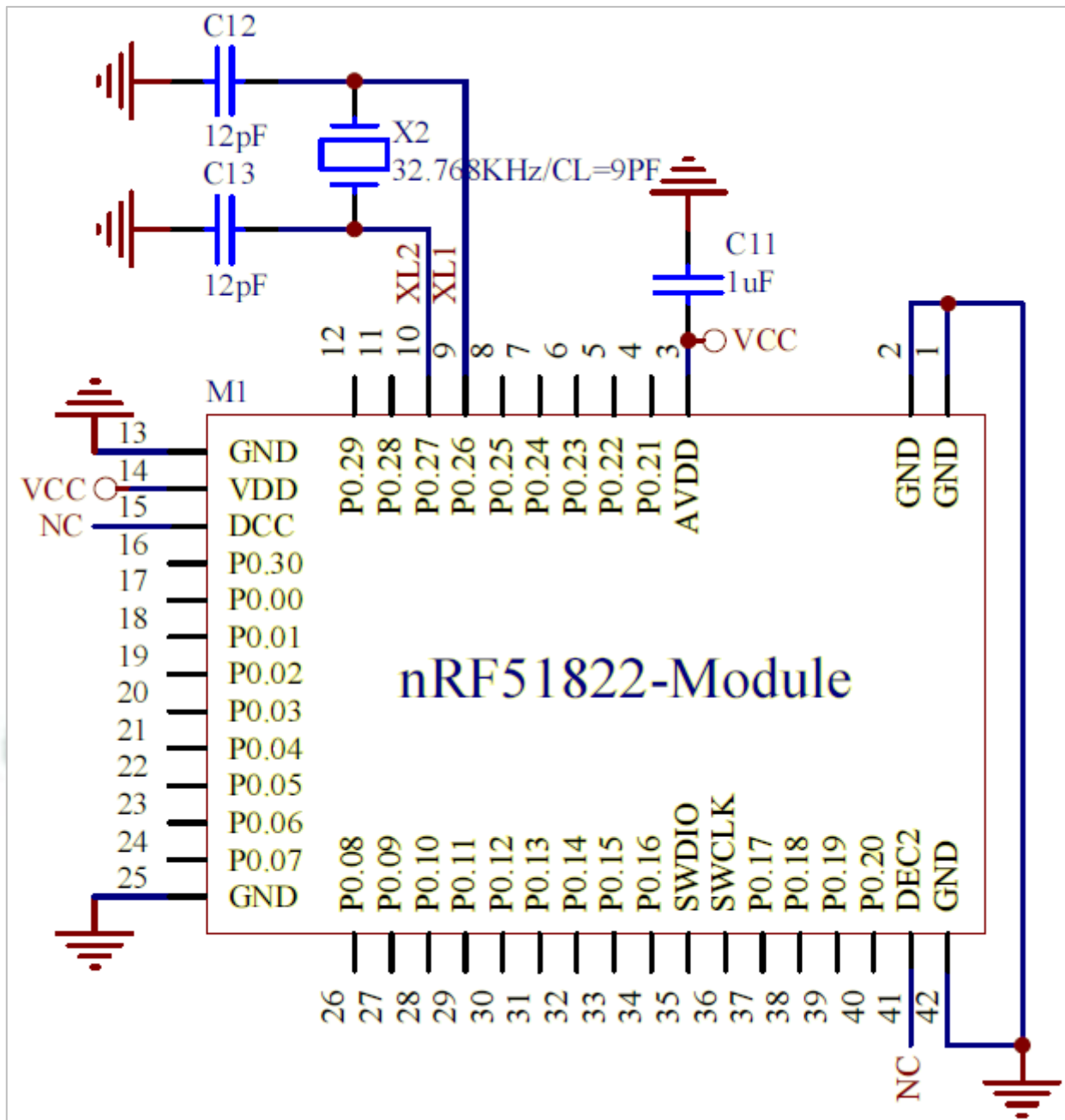

## 8.2 nRF51822 Schematic with 1.8V Low Voltage Mode

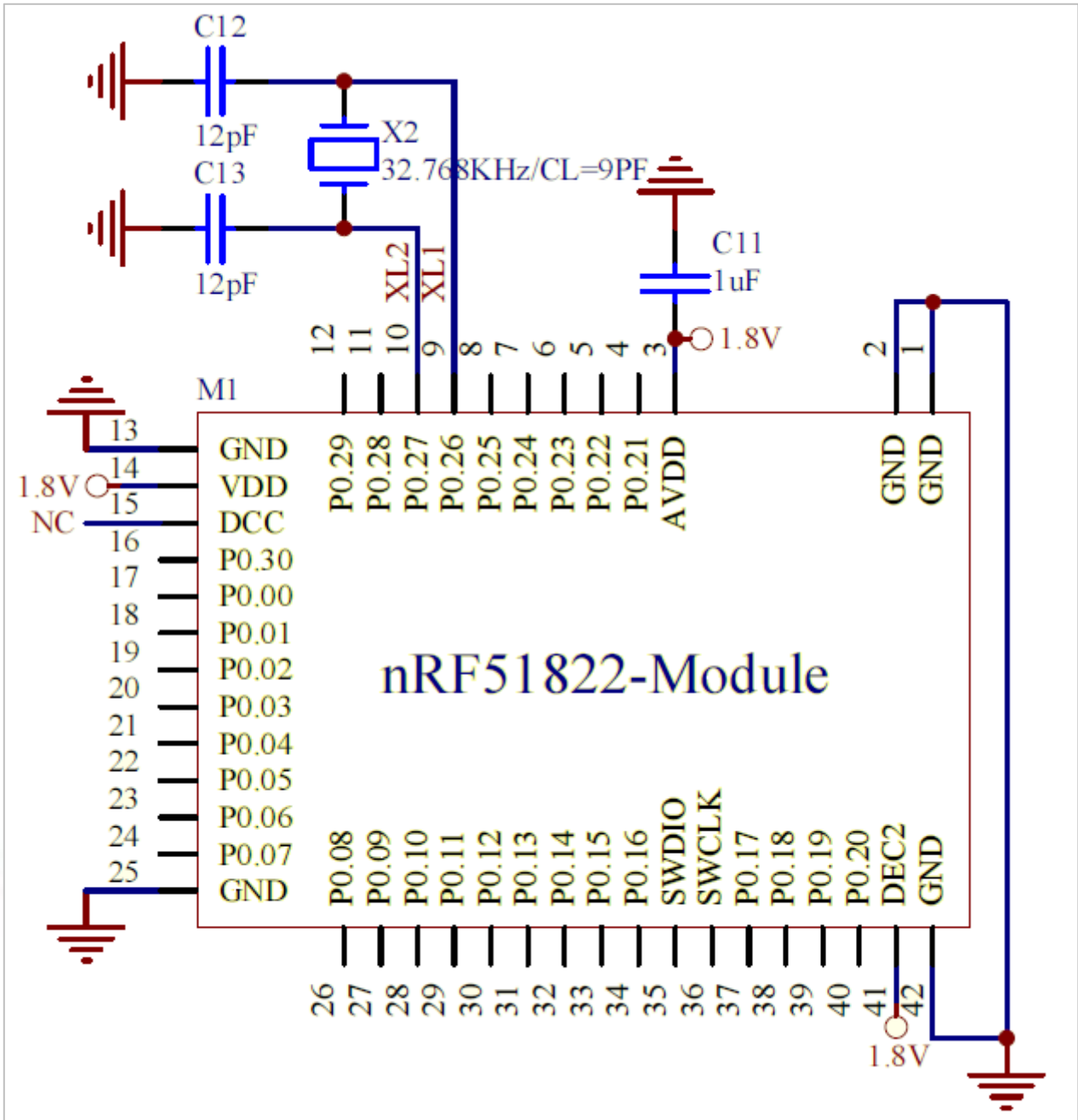

Remark:

When operating temperature is from  $-40^{\circ}\text{C}$  to  $105^{\circ}\text{C}$ , it is not supported 1.8V low voltage mode.

### 8.3 nRF51822 Schematic with Internal DC/DC Converter

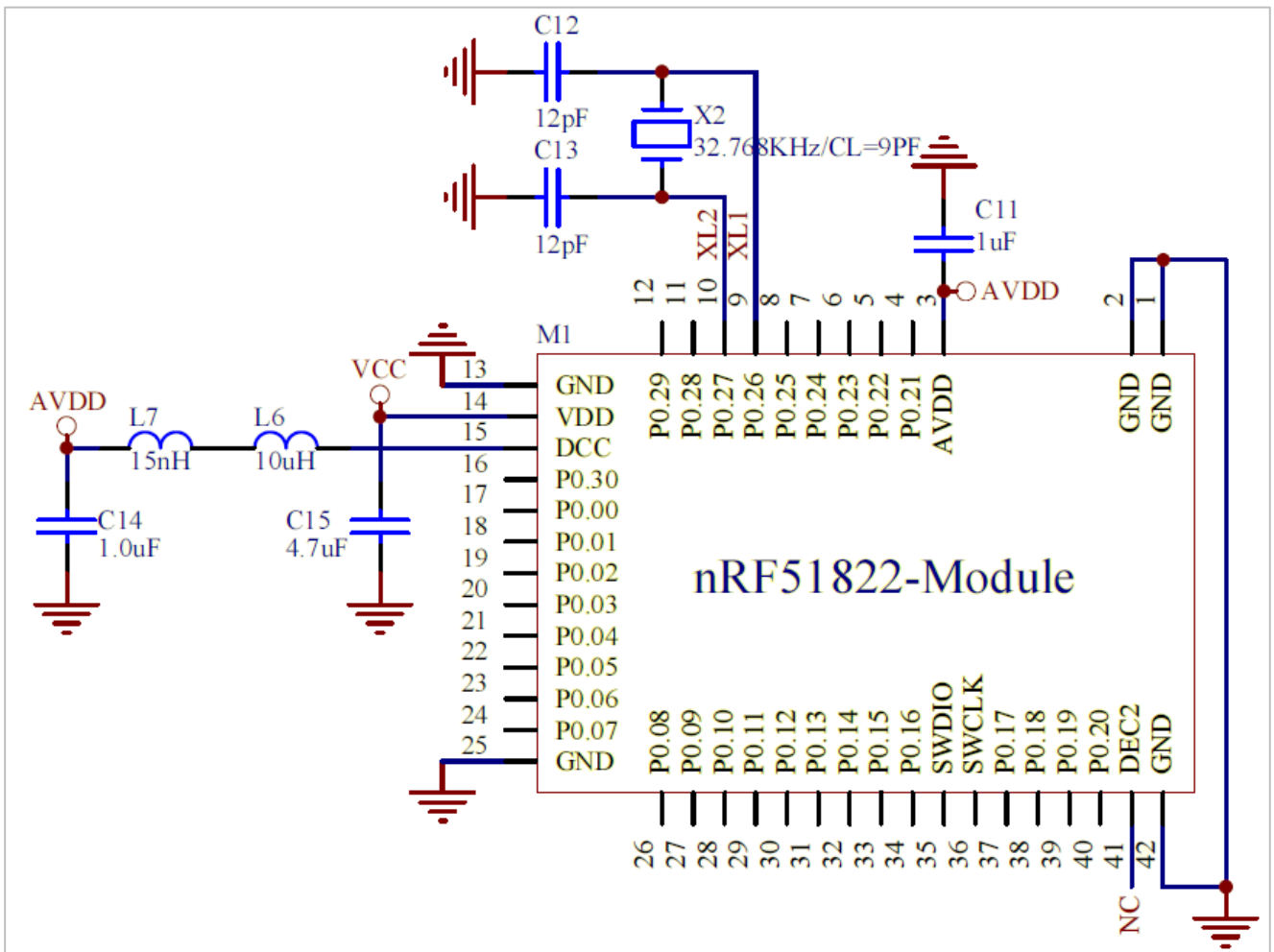

Remark:

Version 3 supports Internal DC/DC Converter, which is not suggested using in Version 2 IC.

# 9. Carrier Keep-Out Area

To make sure wireless performance is at its best condition, please follow instruction below to layout.

Reference Item: MDBT40 / MDBT40-P / MDBT40-ANT / MDBT40-ANT-P Series

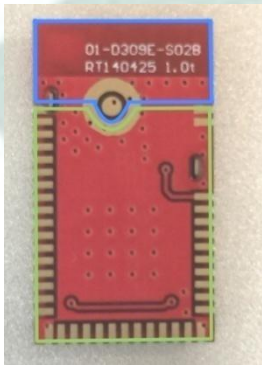
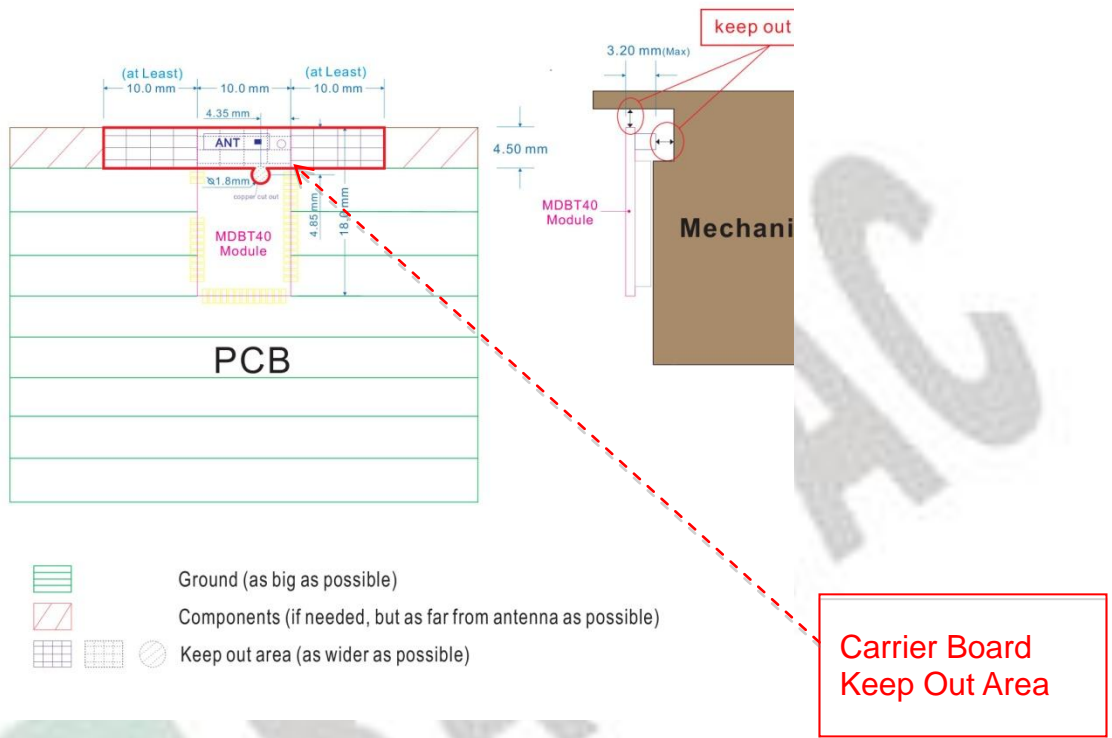

1. Carrier Board under the **BLUE PART** (antenna and test pin pad)  
Carrier Board **is not allowed** to have ground or circuit or components **in any layer**.
2. Carrier Board under the **GREEN PART**
  - a. Suggest to equip ground full green area **in first layer**
  - b. If first layer equipped ground, 2<sup>nd</sup> and 3<sup>rd</sup> layer can have circuit in this area.
  - c. If first layer equipped ground, 4<sup>th</sup> layer can have components in this area.

# 10. Certification

## 10.1 Declaration ID Certification



**QDL** Bluetooth® Qualified Design Listing

---

**The Bluetooth SIG Hereby Recognizes**

**Ginstar Corporation**  
Member Company

**nRF51xxx Bluetooth 4.1 Module**  
Qualified Design Name

Declaration ID: **D023258**  
Qualified Design ID: **60912**  
Specification Name: **4.1**  
Product Type: **End Product**  
Model Number: **MDBT40 / MDBT40-P**  
Listing Date: **02 September 2014**  
Hardware Version Number: **1**

Assessment Date: **02 September 2014**  
Software Version Number: **1**

This certificate acknowledges the *Bluetooth*® Specifications declared by the member were achieved in accordance with the *Bluetooth* Qualification Process as specified within the *Bluetooth* Specifications and as required within the current PRD

---

 **Bluetooth**  
SPECIAL INTEREST GROUP

**Remark: Ginstar Corporation is one of subsidiaries of Raytac Corporation.**

## 10.2 FCC Certification (USA)

<h1 style="font-size: 2em; margin: 0;">TCB</h1>	<p style="margin: 0;"><b>GRANT OF EQUIPMENT AUTHORIZATION</b></p> <p style="margin: 0;">Certification Issued Under the Authority of the Federal Communications Commission</p> <p style="margin: 0;">By:</p>	<h1 style="font-size: 2em; margin: 0;">TCB</h1>												
	<p style="margin: 0;"><b>PHOENIX TESTLAB GmbH</b> Koenigswinkel 10 32825 Blomberg, Germany</p>	<p style="margin: 0;">Date of Grant: 02/17/2014</p> <p style="margin: 0;">Application Dated: 02/17/2014</p>												
<p style="margin: 0;">Raytac Corp. 5F., No.3, Jiankang Rd., Zhonghe Dist., New Taipei City,, 23586 Taiwan</p> <p style="margin: 0;">Attention: Venson Liao , R&amp;D Manager</p>														
<p style="margin: 0;"><b>NOT TRANSFERABLE</b></p> <p style="margin: 0;">EQUIPMENT AUTHORIZATION is hereby issued to the named GRANTEE, and is VALID ONLY for the equipment identified hereon for use under the Commission's Rules and Regulations listed below.</p>														
<p style="margin: 0;">FCC IDENTIFIER: SH6MDBT40</p> <p style="margin: 0;">Name of Grantee: Raytac Corp.</p> <p style="margin: 0;">Equipment Class: Digital Transmission System</p> <p style="margin: 0;">Notes: Bluetooth Module</p> <p style="margin: 0;">Modular Type: Single Modular</p>														
<p style="margin: 0;"><u>Grant Notes</u></p>	<p style="margin: 0;"><u>FCC Rule Parts</u></p>	<table border="0" style="margin: 0 auto;"> <thead> <tr> <th style="text-align: center; padding: 2px;">Frequency Range (MHZ)</th> <th style="text-align: center; padding: 2px;">Output Watts</th> <th style="text-align: center; padding: 2px;">Frequency Tolerance</th> <th style="text-align: center; padding: 2px;">Emission Designator</th> </tr> </thead> <tbody> <tr> <td style="text-align: center; padding: 2px;">2402.0 - 2480.0</td> <td style="text-align: center; padding: 2px;">0.0027</td> <td></td> <td></td> </tr> <tr> <td style="text-align: center; padding: 2px;">2405.0 - 2480.0</td> <td style="text-align: center; padding: 2px;">0.0028</td> <td></td> <td></td> </tr> </tbody> </table>	Frequency Range (MHZ)	Output Watts	Frequency Tolerance	Emission Designator	2402.0 - 2480.0	0.0027			2405.0 - 2480.0	0.0028		
Frequency Range (MHZ)	Output Watts	Frequency Tolerance	Emission Designator											
2402.0 - 2480.0	0.0027													
2405.0 - 2480.0	0.0028													
<p style="margin: 0;">Output power listed is peak conducted. This OEM module is approved for use in products operating as portable transmitting device. End users may not be provided with the module installation instructions.</p>														





Certificate Number: INF412101

This is to certify that the following products have been tested by us with the listed standards and found in conformity with the procedures given in ANSI C63.4-2009 and all tests are performed according to FCC Part 15 and Canada Standard ICES-003 Issue 5 Rules.

This Certificate applies to the tested sample below mentioned only and shall not imply an assessment of the whole production. It is only valid in connection with the test report number: FD412101.

Applicant : Raytac Corporation  
Product Name : BT4.0 module  
Model No. : MDBT40  
Brand Name : Raytac

Applied Standards : FCC Part 15, Subpart B, Class B  
ICES-003 Issue 5  
ANSI C63.4:2009



  
Kent Chen / Assistant Manager  
February 12, 2014

*International Certification Corp.*

Address: No. 3-1, Lane 6, Wen San 3rd St., Kwei Shan Hsiang, Tao Yuan Hsien 333, Taiwan, R.O.C.  
Tel: 886-3-271-8666, Fax: 886-3-318-0155

Rev. 01

## 10.3 TELEC Certification (Japanese)

RCB Japan  
Königswinkel 10  
D-32825 Blomberg, Germany  
Phone: +49 (0) 5235 9500-75  
Fax: +49 (0) 5235 9500-28  
www.phoenix-testlab.de



### Certificate

No: 14-110771

#### of Technical Regulations Conformity for Specified Radio Equipment in Japan

PHOENIX TESTLAB GmbH, operating as a Registered Certification Body (RCB ID: 204) with respect to Japan, declares that the listed product complies with the Technical Regulations Conformity Certification of Specified Radio Equipment (ordinance of MPT N°. 37, 1981), Article 2, Paragraph 1, Item 19.

Product description: **BT4.0 module**  
Trademark / model name: **Raytac / MDBT40**  
Family name: --  
Serial No: --  
Software Release No: --  
Type of emissions: **F1D/G1D**  
Frequency and power: **2402-2480 MHz; 40 ch; 3.0 mW**  
**2405-2480 MHz; 16 ch; 3.0 mW**

Manufacturer: **Raytac Corporation**  
Address: **5F., No.3, Jiankang Rd.,  
Zhonghe Dist**  
City: **23586 New Taipei City**  
Country: **Taiwan**

#### This certificate is granted to:

Certificate holder: **Raytac Corporation**  
Address: **5F., No.3, Jiankang Rd.,  
Zhonghe Dist**  
City: **23586 New Taipei City**  
Country: **Taiwan**

This certificate has 2 annexes.

PHOENIX TESTLAB GmbH  
Königswinkel 10  
32825 Blomberg  
Tel: 0 52 35 95 00 75  
Fax: 0 52 35 95 00 28  
Signature, Stamp

Blomberg, 17 Feb. 2014  
Place, Date

## 10.4 NCC Certificate

# 耕興股份有限公司

## 低功率射頻電機型式認證證明

- (1) 申請者 : 勁達國際電子有限公司  
(臺北市大安區和平東路1段145號5樓之1)
- (2) 製造廠商 : 勁達國際電子有限公司
- (3) 器材名稱 : BT4.0 module
- (4) 廠牌/型號 : Raytac / MDBT40
- (5) 發射功率(電場強度) : 2.402-2.480 GHz: 4.38dBm
- (6) 工作頻率 : 2.402-2.480 GHz (GFSK 40CH, ChS-2MHz)
- (7) 審驗日期 : 104年02月04日
- (8) 審驗合格標籤式樣 :

 CCAF15LP0280T1





### 說明：

1. 請依上列標籤式樣自製標籤，標貼或印鑄於器材本體明顯處，始得販賣或公開陳列。
2. 經型式認證合格之低功率射頻電機，其廠牌、型號、設計、射頻性能如有變更，應重新申請型式認證。
3. 違反低功率電波輻射性電機管理辦法之規定，擅自使用或變更無線電頻率、電功率者，除依電信法規定處罰外，驗證機關(構)並得廢止其型式認證證明或型式認證標籤。
4. 送審廠商應保留送審樣品供日後核對。
5. 本型式認證證明及其合格標籤使用權專屬取得本證明者。依電信管制射頻器材審驗辦法第15條規定，持有人得經由網際網路申請同意他人於同廠牌同型號之電信管制射頻器材使用型式認證標籤，並於次日起30天內，應檢具「電信管制射頻器材審驗合格標籤或符合性聲明標籤同意使用備查表」送國家通訊傳播委員會備查。

### 備註：

1. 本器材符合低功率射頻電機技術規範(第3.10.1章節)之規定。
2. 本器材使用 Chip 天線，天線增益 1.3dBi。
3. 本公司係經國家通訊傳播委員會委託之驗證機構(電信管制射頻器材驗證機構認證證書號碼：NCC-RCB-05/電信終端設備驗證機構認證證書號碼：NCC-RCB-05)，核發本型式認證證明。
4. 依「商品標示法」及「資訊、通信及消費性電子商品標示基準」規定，標示事項貼於商品或內外包裝上，以免違法而受處分。
5. 本案審驗模組為完全模組，適用於任何平台。「平台」定義如下：若器材不組裝本案審驗模組，消費者仍能正常使用該器材主要功能，該器材得視為平台。若器材不組裝本案審驗模組，消費者不能正常使用該器材主要功能，則該器材不能視為平台，該類不同廠牌型號器材組裝本案審驗模組後，須分別申請型式認證。

# 10.5 CE Test Report (EU)

<b>Produkte</b> <i>Products</i>			
<b>Prüfbericht-Nr.:</b> <i>Test Report No.:</i>	<b>10047574 002</b>	<b>Auftrags-Nr.:</b> <i>Order No.:</i>	<b>114024339</b>
		Seite 1 von 26 <i>Page 1 of 26</i>	
<b>Kunden-Referenz-Nr.:</b> <i>Client Reference No.:</i>	<b>N/A</b>	<b>Auftragsdatum:</b> <i>Order date:</i>	<b>July 7, 2014</b>
<b>Auftraggeber:</b> <i>Client:</i>	<b>Raytac Corporation, 5F., No. 3, Jiankang Rd., TW-23586 Zhonghe Dist., New Taipei City, Taiwan, ROC</b>		
<b>Prüfgegenstand:</b> <i>Test item:</i>	<b>Bluetooth 4.1 Module</b>		
<b>Bezeichnung / Typ-Nr.:</b> <i>Identification / Type No.:</i>	<b>MDBT40</b>		
<b>Auftrags-Inhalt:</b> <i>Order content:</i>	<b>Test Report for CE compliance, R&amp;TTE Directive</b>		
<b>Prüfgrundlage:</b> <i>Test specification:</i>	<b>EN 300 328 V 1.8.1            EN 62479:2010            Refer to section 1.1 Test Specifications for more details.</b>		
<b>Wareneingangsdatum:</b> <i>Date of receipt:</i>	<b>7/15/2014</b>		
<b>Prüfmuster-Nr.:</b> <i>Test sample No.:</i>	<b>A000085167-002            A000085167-001</b>		
<b>Prüfzeitraum:</b> <i>Testing period:</i>	<b>21-Jul-2014 - 24-Jul-2014</b>		
<b>Ort der Prüfung:</b> <i>Place of testing:</i>	<b>EMC/RF Laboratory Taipei</b>		
<b>Prüflaboratorium:</b> <i>Testing laboratory:</i>	<b>TUV Rheinland Taiwan Ltd.</b>		
<b>Prüfergebnis*:</b> <i>Test result*:</i>	<b>Pass</b>		
<b>geprüft von / tested by:</b>		<b>kontrolliert von / reviewed by:</b>	
2014-08-04 Ryan W. T. Chen / Project Engineer		2014-08-04 René Charton / Senior Project Manager	
<b>Datum</b> <i>Date</i>	<b>Name / Stellung</b> <i>Name / Position</i>	<b>Unterschrift</b> <i>Signature</i>	<b>Datum</b> <i>Date</i>
			
<b>Sonstiges / Other:</b>			
<b>Zustand des Prüfgegenstandes bei Anlieferung:</b> <i>Condition of the test item at delivery:</i>		<b>Prüfmuster vollständig und unbeschädigt</b> <i>Test item complete and undamaged</i>	
* Legende: 1 = sehr gut 2 = gut 3 = befriedigend 4 = ausreichend 5 = mangelhaft P(ass) = entspricht o.g. Prüfgrundlage(n) F(ail) = entspricht nicht o.g. Prüfgrundlage(n) N/A = nicht anwendbar N/T = nicht getestet			
Legend: 1 = very good 2 = good 3 = satisfactory 4 = sufficient 5 = poor P(ass) = passed a.m. test specification(s) F(ail) = failed a.m. test specification(s) N/A = not applicable N/T = not tested			
<b>Dieser Prüfbericht bezieht sich nur auf das o.g. Prüfmuster und darf ohne Genehmigung der Prüfstelle nicht auszugsweise vervielfältigt werden. Dieser Bericht berechtigt nicht zur Verwendung eines Prüfzeichens.</b> <i>This test report only relates to the a. m. test sample. Without permission of the test center this test report is not permitted to be duplicated in extracts. This test report does not entitle to carry any test mark.</i>			
TÜV Rheinland LGA Products GmbH · Tillystraße 2 · D - 90431 Nürnberg · Tel.: +49 911 655 5225 · Fax: +49 911 655 5226 Mail: service@de.tuv.com · Web: www.tuv.com			

## 10.6 IC Certificate (Canada)

<p>telefication bv The Netherlands Chemin de Commerce 51565536 www.telefication.com</p> <p><b>CB</b> Industry Canada Industrie Canada</p> <p>▶ Reg. No. NL0001</p>		<p><b>telefication</b></p>
<p><b>TECHNICAL ACCEPTANCE CERTIFICATE CERTIFICAT D'ACCEPTABILITÉ CERTIFICATE TECHNIQUE</b></p>		
<p>CERTIFICATION No. No. DE CERTIFICATION</p> <p>TELEFICATION No. No. DE TELEFICATION</p> <p>TEST SITE No. No. DE LABORATOIRE</p> <p>ISSUED TO DELIVRÉ À</p> <p>TYPE OF EQUIPMENT GENRE DE MATÉRIEL</p> <p>TRADE NAME AND MODEL MARQUE ET MODÈLE</p> <p>CERTIFIED TO CERTIFIÉ SELON LE</p>	<p>▶ 8017A-MDBT40</p> <p>▶ 152170125/AA/00</p> <p>▶ 4620A-5</p> <p>▶ Raytac Corporation</p> <p>▶ Bluetooth Device Modular Approval</p> <p>▶ Raytac MUB14U</p> <p>▶ SPECIFICATION CAHIER DES CHARGES</p>	<p>RSS-247</p> <p>ISSUE EDITION</p> <p>Issue 1</p>
<p>Certification of equipment means only that the equipment has met the requirements of the above-noted specification. Licence applications, where applicable to use certified equipment, are acted on accordingly by the Industry Canada issuing office and will depend on the existing radio environment, service and location of operation. This certificate is issued on condition that the holder complies and will continue to comply with the requirements and procedures issued by Industry Canada. The equipment for which this certificate is issued shall not be manufactured, imported, distributed, leased, offered for sale or sold unless the equipment complies with the applicable technical specifications and procedures issued by Industry Canada.</p> <p>La certification du matériel signifie seulement que le matériel a satisfait aux exigences de la norme indiquée ci-dessus. Les demandes de licences nécessaires pour l'utilisation du matériel certifié sont traitées en conséquence par le bureau de délivrance d'Industrie Canada et dépendent des conditions radio ambiantes, du service et de l'emplacement d'exploitation. Le présent certificat est délivré à la condition que le titulaire satisfasse et continue de satisfaire aux exigences et aux procédures d'Industrie Canada. Le matériel à l'égard duquel le présent certificat est délivré ne doit pas être fabriqué, importé, distribué, loué, mis en vente ou vendu à moins d'être conforme aux procédures et aux spécifications techniques applicables publiées par Industrie Canada.</p>		
<p>ISSUED BY TELEFICATION BV, RECOGNIZED CERTIFICATION BODY BY INDUSTRY CANADA DELIVRÉ PAR TELEFICATION BV, ORGANISME DE CERTIFICATION RECONNU PAR INDUSTRIE CANADA</p>		
<p><i>I hereby attest that the subject equipment was tested and found in compliance with the above-noted specification. J'atteste, par la présente, que le matériel a fait l'objet d'essai et a été jugé conforme à la spécification ci-dessus.</i></p>		
<p>DATE 15 June 2015 BY</p> <p>This certificate has one annex.</p>	<p>W.J.M. Jong Manager Product Certification</p> <p>i.o. </p>	

## 10.7 SRRC Certificate (China)

**无线电发射设备**  
Radio Transmission Equipment  
**型号核准证**  
Type Approval Certificate

劲达国际电子有限公司（台湾）：

**根据《中华人民共和国无线电管理条例》，经审查，下列无线电发射设备**  
In accordance with the provisions on the Radio  
Regulations of the People's Republic of China , the following  
**符合中华人民共和国无线电管理规定和**  
radio transmission equipment , after examination , conforms  
**技术标准，其核准代码为：CMIIT ID: 2015DJ2435**  
to the provisions with its CMIIT ID:

  
(发证机关)  
Sealed by issuing authority

有效期：五年  
Validity

2015 年 6 月 2 日  
Year Month Date

# 10.8 RoHS Report



## 測試報告

## Test Report

號碼(No.) : CE/2014/93151      日期(Date) : 2014/09/23      頁數(Page): 2 of 6

勁達國際電子有限公司  
 RAYTAC CORPORATION  
 新北市中和區建康路3號5樓  
 5F, NO. 3, JIANKANG RD., ZHONGHE DIST, NEW TAIPEI CITY 23586, TAIWAN (R. O. C.)



### 測試結果(Test Results)

測試部位(PART NAME)No.1 : 整體混測 (MIXED ALL PARTS)

測試項目 (Test Items)	單位 (Unit)	測試方法 (Method)	方法偵測 極限值 (MDL)	結果 (Result) No.1
鎘 / Cadmium (Cd)	mg/kg	參考 IEC 62321-5: 2013 方法, 以感應耦合電漿原子發射光譜儀檢測。 / With reference to IEC 62321-5: 2013 and performed by ICP-AES.	2	n.d.
鉛 / Lead (Pb)	mg/kg	參考 IEC 62321-5: 2013 方法, 以感應耦合電漿原子發射光譜儀檢測。 / With reference to IEC 62321-5: 2013 and performed by ICP-AES.	2	11
汞 / Mercury (Hg)	mg/kg	參考 IEC 62321-4: 2013 方法, 以感應耦合電漿原子發射光譜儀檢測。 / With reference to IEC 62321-4: 2013 and performed by ICP-AES.	2	n.d.
六價鉻 / Hexavalent Chromium Cr(VI)	mg/kg	參考 IEC 62321: 2008 方法, 以UV-VIS 檢測。 / With reference to IEC 62321: 2008 and performed by UV-VIS.	2	n.d.
多溴聯苯總和 / Sum of PBBs	mg/kg	參考 IEC 62321: 2008 方法, 以氣相層析/質譜儀檢測。 / With reference to IEC 62321: 2008 and performed by GC/MS.	-	n.d.
一溴聯苯 / Monobromobiphenyl	mg/kg		5	n.d.
二溴聯苯 / Dibromobiphenyl	mg/kg		5	n.d.
三溴聯苯 / Tribromobiphenyl	mg/kg		5	n.d.
四溴聯苯 / Tetrabromobiphenyl	mg/kg		5	n.d.
五溴聯苯 / Pentabromobiphenyl	mg/kg		5	n.d.
六溴聯苯 / Hexabromobiphenyl	mg/kg		5	n.d.
七溴聯苯 / Heptabromobiphenyl	mg/kg		5	n.d.
八溴聯苯 / Octabromobiphenyl	mg/kg		5	n.d.
九溴聯苯 / Nonabromobiphenyl	mg/kg		5	n.d.
十溴聯苯 / Decabromobiphenyl	mg/kg	5	n.d.	

This document is issued by the Company subject to its General Conditions of Service printed overleaf, available on request or accessible at <http://www.sgs.com/en/Terms-and-Conditions.aspx> and, for electronic format documents, subject to Terms and Conditions for Electronic Documents at <http://www.sgs.com/en/Terms-and-Conditions/ermise-Documents.aspx>. Attention is drawn to the limitation of liability, indemnification and jurisdiction issues defined therein. Any holder of this document is advised that information contained hereon reflects the Company's findings at the time of its intervention only and within the limits of client's instruction, if any. The Company's sole responsibility is to its Client and this document does not exonerate parties to a transaction from exercising all their rights and obligations under the transaction documents. This document cannot be reproduced, except in full, without prior written approval of the Company. Any unauthorized alteration, forgery or falsification of the content or appearance of this document is unlawful and offenders may be prosecuted to the fullest extent of the law. Unless otherwise stated the results shown in this test report refer only to the sample(s) tested.

SGS Taiwan Ltd. 台灣檢驗科技股份有限公司 | 33, Wu Chuan Rd., New Taipei Industrial Park, New Taipei City, Taiwan / 新北市新北產業園區五權路33號  
 T+886 (02)2299 3279 F+886 (02)2299 3237 www.sgs.tw

Member of the SGS Group



## 測試報告

號碼(No.) : CE/2014/93151

日期(Date) : 2014/09/23

頁數(Page): 3 of 6

## Test Report

勁達國際電子有限公司

RAYTAC CORPORATION

新北市中和區建康路3號5樓

5F, NO. 3, JIANKANG RD., ZHONGHE DIST, NEW TAIPEI CITY 23586, TAIWAN (R. O. C.)



測試項目 (Test Items)	單位 (Unit)	測試方法 (Method)	方法偵測 極限值 (MDL)	結果 (Result) No.1
多溴聯苯醚總和 / Sum of PBDEs	mg/kg	參考 IEC 62321: 2008 方法, 以氣相層析/質譜儀檢測. / With reference to IEC 62321: 2008 and performed by GC/MS.	-	n.d.
一溴聯苯醚 / Monobromodiphenyl ether	mg/kg		5	n.d.
二溴聯苯醚 / Dibromodiphenyl ether	mg/kg		5	n.d.
三溴聯苯醚 / Tribromodiphenyl ether	mg/kg		5	n.d.
四溴聯苯醚 / Tetrabromodiphenyl ether	mg/kg		5	n.d.
五溴聯苯醚 / Pentabromodiphenyl ether	mg/kg		5	n.d.
六溴聯苯醚 / Hexabromodiphenyl ether	mg/kg		5	n.d.
七溴聯苯醚 / Heptabromodiphenyl ether	mg/kg		5	n.d.
八溴聯苯醚 / Octabromodiphenyl ether	mg/kg		5	n.d.
九溴聯苯醚 / Nonabromodiphenyl ether	mg/kg		5	n.d.
十溴聯苯醚 / Decabromodiphenyl ether	mg/kg	5	n.d.	

### 備註(Note) :

1. mg/kg = ppm ; 0.1wt% = 1000ppm
2. n.d. = Not Detected (未檢出)
3. MDL = Method Detection Limit (方法偵測極限值)
4. "-" = Not Regulated (無規格值)
5. 樣品的測試是基於申請人要求混合測試, 報告中的混合測試結果不代表其中個別單一材質的含量. (The samples was/were analyzed on behalf of the applicant as mixing sample in one testing. The above results was/were only given as the informality value.)

This document is issued by the Company subject to its General Conditions of Service printed overleaf, available on request or accessible at <http://www.sgs.com/en/Terms-and-Conditions.aspx> and, for electronic format documents, subject to Terms and Conditions for Electronic Documents at <http://www.sgs.com/en/Terms-and-Conditions/Termse-Document.aspx>. Attention is drawn to the limitation of liability, indemnification and jurisdiction issues defined therein. Any holder of this document is advised that information contained hereon reflects the Company's findings at the time of its intervention only and within the limits of client's instruction, if any. The Company's sole responsibility is to its Client and this document does not exonerate parties to a transaction from exercising all their rights and obligations under the transaction documents. This document cannot be reproduced, except in full, without prior written approval of the Company. Any unauthorized alteration, forgery or falsification of the content or appearance of this document is unlawful and offenders may be prosecuted to the fullest extent of the law. Unless otherwise stated the results shown in this test report refer only to the sample(s) tested.

SGS Taiwan Ltd. 台灣檢驗科技股份有限公司

33, Wu Chuan Rd., New Taipei Industrial Park, New Taipei City, Taiwan / 新北市新北產業園區五權路33號  
t+886 (02)2299 3279 f+886 (02)2299 3237 www.sgs.tw

Member of the SGS Group



## 10.9 Reliability Test

Below are the extracted events from reliability test. Please contact us for full report.

- Tested Item: MDBT40 / MDBT40-P
- Testing Method:  
Conducted continuously BLE transmitting and receiving function checking during requested duration.
- Testing Result: No fault or package loss during testing.
- Testing Events:
  1. Operating under Low Temperature Test

Test Method/ Specification:

Test method:	<u>Refer to JASO D001-94, Clause 5.13</u>
Sample condition:	<u>Operating</u>
Temperature:	<u>-30°C</u>
Duration:	<u>72 Hours</u>

2. Operating under High Temperature Test

Test Method/ Specification:

Test method:	<u>Refer to JASO D001-94, Clause 5.15</u>
Sample condition:	<u>Operating</u>
Temperature:	<u>85°C</u>
Duration:	<u>120 Hours</u>

3. Thermal Shock Test

Test Method/ Specification:

Test method: Refer to JASO D001-94, Clause 5.17

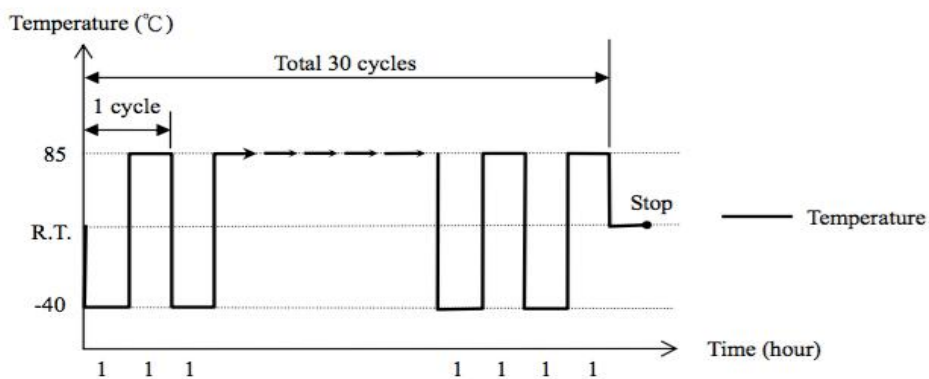

- Sample Condition: Operating
- The temperature transition time shall be within 1 minute.
- Examine the appearance of specimen(s) by visual check and perform functional check after this test.
- Functional check: Connect the specimen(s) with notebook and rated power ( 2V<sub>DC</sub> ) then examine whether the signal transmission could be work normally or not.

## 4. Temperature Cycling Test

### 1. Temperature Cycling Test:

#### Test Equipment:

Name	Brand	Model	Serial No.
Programmable Temperature & Humidity Chamber	KSON	THS-D4T-150-LN2	D129
Programmable DC Power Supply	GW	PSM-2010	PH220347

#### Lab Environmental Conditions:

Ambient Temperature:  $(25 \pm 3) ^\circ\text{C}$

Ambient humidity:  $(55 \pm 20) \% \text{RH}$

#### Test Method/ Specification:

##### Condition I:

Test method: Refer to JASO D001-94, Clause 5.18

Step	Temperature ( $^\circ\text{C}$ )	Humidity (%RH)	Time (hours)	Sample Condition
1	23	60	4	Operating
2	23→55	60→95	0.5	Operating
3	55	95	10	Operating
4	55→-40	95→0	2.5	Non-Operating
5	-40	0	2	Non-Operating
6	-40→85	0	1.5	Non-Operating
7	85	0	2	Operating
8	85→23	0	1.5	Operating

Test cycle: Total 10 cycles.

- Examine the appearance of specimen(s) by visual check and perform functional check after this test.
- Functional check: Connect the specimen(s) with notebook and rated power ( $2V_{DC}$ ) then examine whether the signal transmission could be work normally or not.

##### Condition II:

Test method: Refer to JASO D001-94, Clause 5.18

Step	Temperature ( $^\circ\text{C}$ )	Humidity (%RH)	Time (hours)	Sample Condition
1	23	60	4	Operating
2	23→55	60→95	0.5	Operating
3	55	95	10	Operating
4	55→-40	95→0	2.5	Operating
5	-40	0	2	Operating
6	-40→85	0	1.5	Operating
7	85	0	2	Operating
8	85→23	0	1.5	Operating

Test cycle: Total 1 cycle.

Note: Condition II is start after Condition I complete

- Examine the appearance of specimen(s) by visual check and perform functional check after this test.
- Functional check: Connect the specimen(s) with notebook and rated power ( $2V_{DC}$ ) then examine whether the signal transmission could be work normally or not.

## 10.10 End-Product Label

Customers are suggested using following label content adding to package or user manual for FCC, TELEC, NCC, IC, and SRRC certification.

### **FCC (USA)**

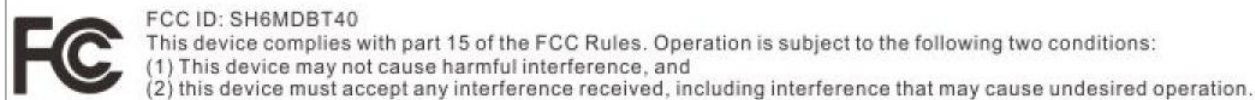

### **TELEC (Japan)**

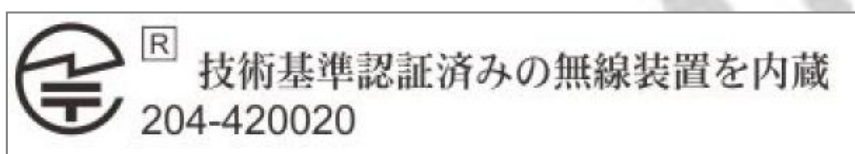

### **NCC (Taiwan)**

MDBT40 Series

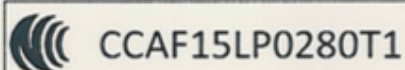

MDBT40-P Series

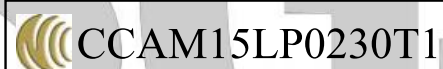

平台廠商需於平台上標示<本產品內含射頻模  CCAF15LP0280T1 字樣>

註：平台定義為若器材不組裝本模組，消費者仍能正常使用本器材之主要功能，該器材得視為平台。

## **IC (Canada)**

### **Required end product labeling:**

Any device incorporating this module must include an external, visible, permanent marking or label which states: "Contains IC: 8017A-MDBT40."

### **Manual Information to the End User**

The OEM integrator has to be aware not to provide information to the end user regarding how to install or remove this RF module in the user's manual of the end product which integrates this module.

The end user manual shall include all required regulatory information/warning as show in this manual.

## **SRRC (China)**

(二) 对于嵌入了“完整的非独立操作使用的无线电发射模块”的可独立使用的设备，应在设备标签或说明书中标明如下信息：

本设备包含型号核准代码（分别）为：CMIIT ID: XXXXYZZZZ, ... 的无线电发射模块。

## 11. Current Consumption Reference Data (BT 3.0 VS BT 4.0)

<b>Mouse Power Consumption</b>			
	<b>BT4.0 (Based on nRF51822)</b>		<b>BT3.0</b>
	BT4.0 Mode	RF2.4GHz	
2 x AAA	9.5 Months	10 Months	2.9 Months
2 x AA	21 Months	22 Months	6.2 Months
Including Sensor	<b>BT4.0 (Based on nRF51822)</b>		<b>BT3.0 @3V</b>
	BT4.0 Mode @ 1.5V	RF2.4GHz @1.5V	
Active-Mouse moving (4.3%) (7.5ms report rate)	5.4 mA 8.1 mW	5.8 mA 8.7 mW	8.7 mA 26.1 mW
Rest 1>1s (4.1%) Link maintained Sensor latency: 20ms	900 uA 1.35 mW	350 uA No link 1.05 mW	1.24 mA 3.72 mW
Rest 2>10 sec (4.9%) Link maintained Sensor latency: 100ms	680 uA 1.02 mW	120 uA 198 uW	900 uA 2.7 mW
Rest 2d>60 sec Link maintained Sensor latency: 100ms	120 uA 180 uW	120 uA 198 uW	900 uA 2.7 mW
Rest 3>600s (86.3) Link disconnected Sensor latency: 500ms	90 uA 135 uW	90 uA 135 uW	797 uA 2.3 mW

<b>Keyboard Power Consumption</b>			
	<b>BT4.0 (Based on nRF51822)</b>		<b>BT3.0 @3V</b>
	BT4.0 Mode @3V	RF2.4GHz @3V	
Active 6 letters/s	200 uA	5.8 mA 8.7 mW	8.7 mA 26.1 mW
Rest 1 Maintain link	20 - 40 uA	NA	20 - 40 uA
Rest 2 after>1min, disconnected	0.8 uA	0.8 uA	2 uA Only when PC is off

## 12. BT 4.0 Product Certification Cost Comparison Chart

<b>(First Certification Application)</b>			
	Chip-on-board Built Up Product	Apply Raytac Module MDBT40 to Build Product	Raytac Module Saving
Declaration ID	US\$8,000	US\$8,000	<b>Every Single Customer &amp; Every Single Product Certification Cost Saving</b>
BQB Test	US\$7,000	US\$2,000 (*Note 1)	
USA FCC Test for BT4.0	US\$3,600	US\$0	
Japan Telec Test for BT4.0	US\$5,500	US\$0	
CE RF Certification	US\$4,500	US\$0	
IC (Canada) Certificate	US\$3,600	US\$0	
SRRC (China) Certificate	US\$8,500	US\$0	
Taiwan NCC	US\$3,600	US\$0	
CE & FCC Part 15B EMC Testing	US\$1,800	US\$1,800	
<b>Total</b>	<b>US\$46,100</b>	<b>US\$11,800</b>	<b>US\$34,300</b>

<b>(2nd and Later Series Product Certification Application)</b>			
	Chip-on-board Built Up Product	Apply Raytac Module MDBT40 to Build Product	Raytac Module Saving
Declaration ID	US\$8,000	US\$0	<b>Every Single Customer &amp; Every Single Product Certification Cost Saving</b>
BQB Test	US\$7,000	US\$0	
USA FCC Test for BT4.0	US\$3,600	US\$0	
Japan Telec Test for BT4.0	US\$5,500	US\$0	
CE RF Certification	US\$4,500	US\$0	
IC (Canada) Certificate	US\$3,600	US\$0	
SRRC (China) Certificate	US\$8,500	US\$0	
Taiwan NCC	US\$3,600	US\$0	
CE & FCC Part 15B EMC Testing	US\$1,800	US\$1,800	
<b>Total</b>	<b>US\$46,100</b>	<b>US\$1,800</b>	<b>US\$44,300</b>
<b>Note:</b>	1. BQB test based on single profile 2. Declaration ID cost based on Adopter Membership	1. FCC & Telec applicant is Raytac (For the case of copy report to change the applicant, the cost is about US\$1800 for FCC & US\$2,800 for Telec)	

Above cost provided for reference, it may be varied according to different testing lab.

### 13. nRF51 IC Compatibility with SDK & SoftDevice

nRF51 IC rev.	nRF51 SDK	SoftDevices									
		nRF51422/nRF51822						nRF51422			
		S110		S120		S130		S210		S310	
		SD	SDS	SD	SDS	SD	SDS	SD	SDS	SD	SDS
1	4.4.2	5.2.1 <sup>a</sup>	1.1	-	-	-	-	2.0.0 <sup>b</sup>	1.0	-	-
2	4.4.2	5.2.1	1.1	-	-	-	-	3.0.0	1.2	-	-
	5.2.0	6.0.0 6.2.1	1.2					3.0.0	1.2	1.0.0	1.0
	6.1.0	7.0.0 7.1.0	1.3	1.0.1	1.1			3.0.0	1.2	1.0.0	1.0
	-	8.0.0	2.0	2.0.0	2.1			4.0.1	2.0	2.0.1	2.0
3	6.1.0	7.1.0	1.3	1.0.1	1.1	-	-	3.0.0	1.2	1.0.0	1.0
	7.0.1					4.0.1	2.0	-	-		
	7.1.0					4.0.1	2.0	2.0.1	2.0		
	7.2.0					4.0.1	2.0	2.0.1	2.0		
	8.0.0	8.0.0	2.0	2.0.0	2.1	0.5.0-1 alpha	0.5	4.0.1	2.0	-	-
	8.1.0					1.0.0	1.0				

- a. Valid for nRF51822 only.
- b. Preprogrammed in factory.

The SDK version must match with its corresponding softdevice version to make BLE work.

**Remark: Above table is extracted from document “nRF51 Series Compatibility Matrix”. Any updates shall refer to Nordic’s official release as final reference.**

# Release Note

- 2015/02/13 Version. A1: NCC certificate in Chapter 10 added.
- 2015/04/29 Version A2:
  - (1) Added MDBT40-P Spec, RoHS Report, List of Raytac's Model No.
  - (2) Updated Chapter 8, 9, and 12, 13.
- 2015/07/01 Version A3: Adding IC & SRRC certificates.
- 2015/11/03 Version A4:
  - (1) Revised layout guide for MDBT40 series in Chapter 2.
  - (2) Updated Chapter 5.
  - (3) Updated table of List of Raytac's Model No.
  - (4) Removed info of V2 module from Chapter 4.
  - (5) Added Reliability Test in Chapter 10.

