

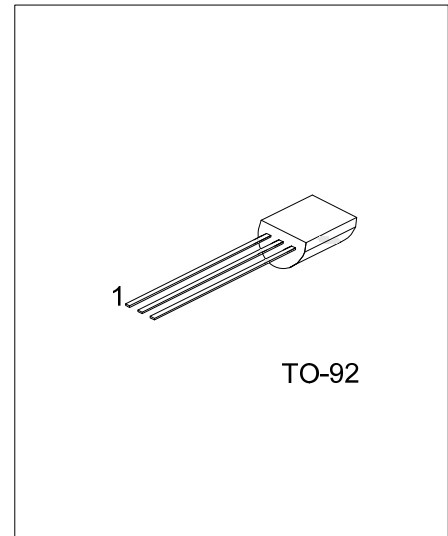

2SC945

NPN SILICON TRANSISTOR

**AUDIO FREQUENCY
AMPLIFIER HIGH FREQUENCY
OSC NPN TRANSISTOR**



■ **DESCRIPTION**

The UTC **2SC945** is an audio frequency amplifier high frequency OSC NPN transistor.

■ **FEATURES**

- * Collector-Emitter voltage:
BV_{CBO}=50V
- * Collector current up to 150mA
- * High h_{FE} linearity
- * Complimentary to UTC 2SA733

■ **ORDERING INFORMATION**

Order Number		Package	Pin Assignment			Packing
Lead Free Plating	Halogen Free		1	2	3	
2SC945L-x-T92-B	2SC945G-x-T92-B	TO-92	E	C	B	Tape Box
2SC945L-x-T92-K	2SC945G-x-T92-K	TO-92	E	C	B	Bulk

Note: Pin Assignment: E: Emitter C: Collector B: Base

<p>2SC945L-x-T92-B</p>	<p>(1) B: Tape Box, K: Bulk (2) T92: TO-92 (3) x: refer to Classification of h_{FE} (4) L: Lead Free, G: Halogen Free</p>
------------------------	---

■ **MARKING**

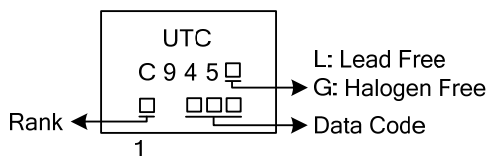

■ ABSOLUTE MAXIMUM RATINGS ($T_A=25^\circ\text{C}$, unless otherwise specified)

PARAMETER	SYMBOL	RATING	UNIT
Collector-Base Voltage	V_{CBO}	60	V
Collector-Emitter Voltage	V_{CEO}	50	V
Emitter-Base Voltage	V_{EBO}	5	V
Collector Dissipation($T_a=25^\circ\text{C}$)	P_C	250	mW
Collector Current	I_C	150	mA
Base Current	I_B	50	mA
Junction Temperature	T_J	125	$^\circ\text{C}$
Storage Temperature	T_{STG}	-55 ~ +150	$^\circ\text{C}$

Note: Absolute maximum ratings are those values beyond which the device could be permanently damaged. Absolute maximum ratings are stress ratings only and functional device operation is not implied.

■ ELECTRICAL CHARACTERISTICS ($T_A=25^\circ\text{C}$, unless otherwise specified)

PARAMETER	SYMBOL	TEST CONDITIONS	MIN	TYP	MAX	UNIT
Collector-Base Breakdown Voltage	BV_{CBO}	$I_C=100\mu\text{A}$, $I_E=0$	60			V
Collector-Emitter Breakdown Voltage	BV_{CEO}	$I_C=10\text{mA}$, $I_B=0$	50			V
Collector Cut-Off Current	I_{CBO}	$V_{CB}=40\text{V}$, $I_E=0$			100	nA
Emitter Cut-Off Current	I_{EBO}	$V_{EB}=3\text{V}$, $I_C=0$			100	nA
DC Current Gain	h_{FE}	$V_{CE}=6\text{V}$, $I_C=1\text{mA}$	90		600	
Collector-Emitter Saturation Voltage	$V_{CE(SAT)}$	$I_C=100\text{mA}$, $I_B=10\text{mA}$		0.1	0.3	V
Current Gain Bandwidth Product	f_T	$V_{CE}=10\text{V}$, $I_C=50\text{mA}$	100	190		MHz
Output Capacitance	C_{ob}	$V_{CB}=10\text{V}$, $I_E=0$, $f=1\text{MHz}$		2.0	3.0	pF
Noise Figure	NF	$I_C=-0.1\text{mA}$, $V_{CE}=6\text{V}$ $R_G=10\text{k}\Omega$, $f=100\text{Hz}$		4.0	6.0	dB

■ CLASSIFICATION OF h_{FE}

RANK	R	Q	P	K
RANGE	90-180	135-270	200-400	300-600

■ TYPICAL CHARACTERISTICS

Static Characteristics

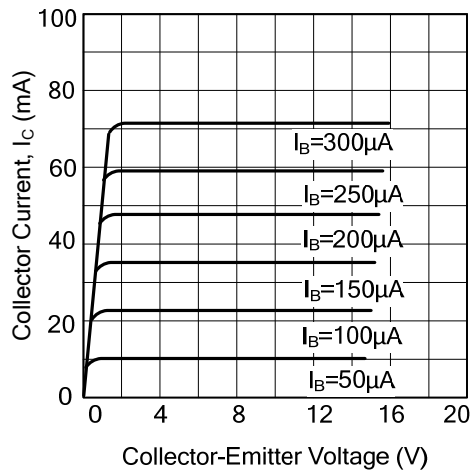

DC Current Gain

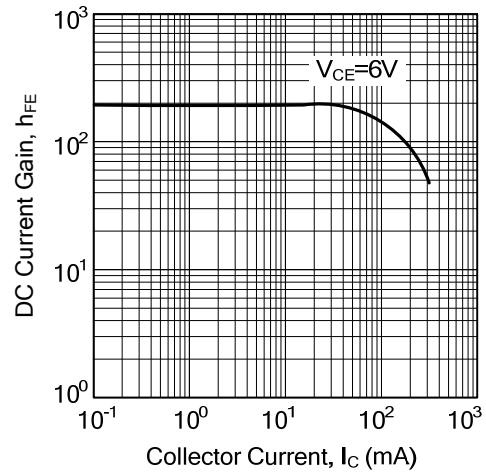

Base-Emitter on Voltage

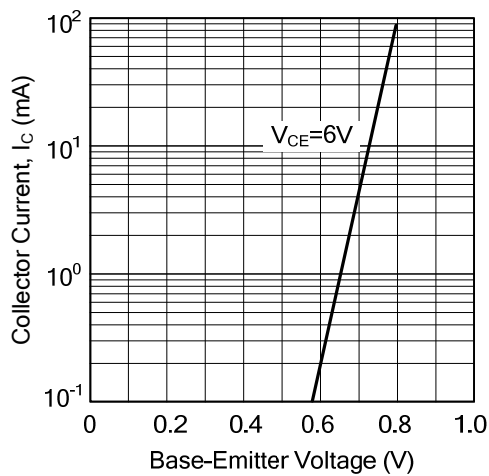

Saturation Voltage

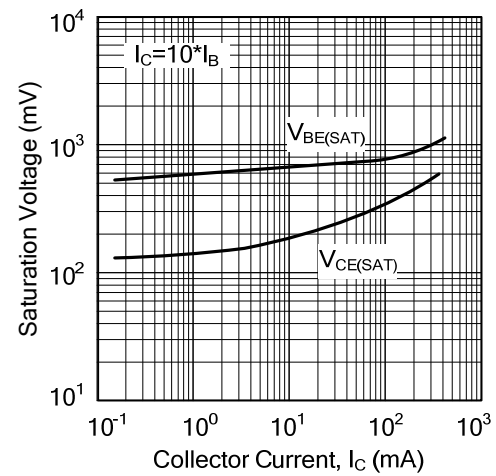

Current Gain-Bandwidth Product

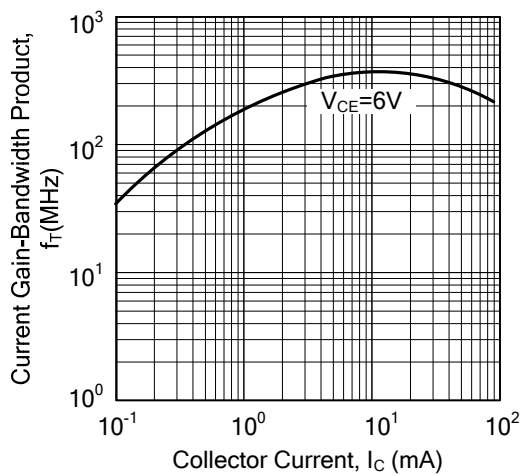

Collector Output Capacitance

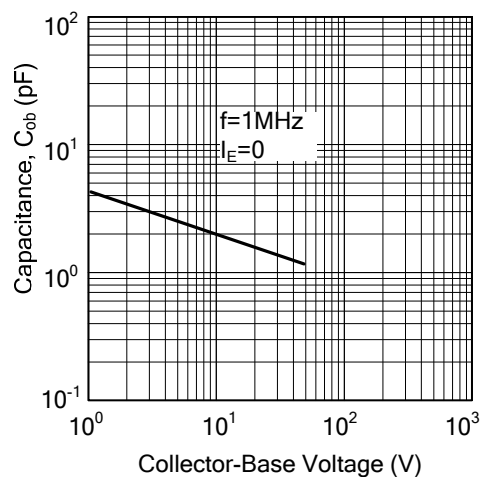

UTC assumes no responsibility for equipment failures that result from using products at values that exceed, even momentarily, rated values (such as maximum ratings, operating condition ranges, or other parameters) listed in products specifications of any and all UTC products described or contained herein. UTC products are not designed for use in life support appliances, devices or systems where malfunction of these products can be reasonably expected to result in personal injury. Reproduction in whole or in part is prohibited without the prior written consent of the copyright owner. The information presented in this document does not form part of any quotation or contract, is believed to be accurate and reliable and may be changed without notice.