



2SD880

NPN SILICON TRANSISTOR

NPN EPITAXIAL TRANSISTOR

DESCRIPTION

The UTC **2SD880** is designed for audio frequency power amplifier applications.

FEATURES

- * High DC Current Gain: $h_{FE}=200(\text{Max.})(V_{CE}=5V, I_C=0.5A)$
- * Low Saturation Voltage: $V_{CE(SAT)}=1.0V(\text{Max.})(I_C=3A, I_B=0.3A)$
- * High Power Dissipation: $P_C=30W (T_C=25^\circ\text{C})$
- * Complementary to 2SB834

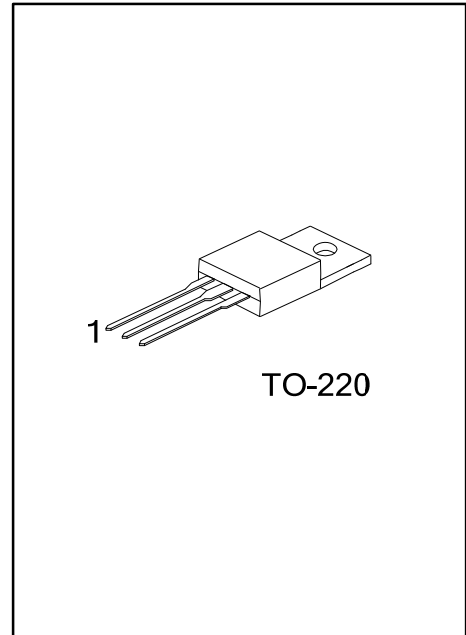

ORDERING INFORMATION

Ordering Number		Package	Pin Assignment			Packing
Lead Free	Halogen Free		1	2	3	
2SD880L-TA3-T	2SD880G-TA3-T	TO-220	B	C	E	Tube

<p>2SD880L-TA3-T</p> <p>(1) Packing Type</p> <p>(2) Package Type</p> <p>(3) Lead Free</p>	<p>(1) T: Tube</p> <p>(2) TA3: TO-220</p> <p>(3) G: Halogen Free, L: Lead Free</p>
---	--

■ ABSOLUTE MAXIMUM RATINGS

PARAMETER		SYMBOL	RATINGS	UNIT
Collector to Base Voltage		V_{CBO}	60	V
Collector to Emitter Voltage		V_{CEO}	60	V
Emitter to Base Voltage		V_{EBO}	7	V
Collector Current		I_C	3	A
Base Current		I_B	0.5	A
Power Dissipation (Derate at $T_C > 25^\circ\text{C}$)		P_D	30	W
Junction Temperature	$T_A=25$	T_J	1.5	W
	$T_C=25$		30	
Storage Temperature		T_{STG}	-55~+150	$^\circ\text{C}$

Note: Absolute maximum ratings are those values beyond which the device could be permanently damaged.

Absolute maximum ratings are stress ratings only and functional device operation is not implied.

■ ELECTRICAL CHARACTERISTICS ($T_A = 25^\circ\text{C}$)

PARAMETER	SYMBOL	TEST CONDITIONS	MIN	TYP	MAX	UNIT
Collector-Emitter Breakdown Voltage	BV_{CEO}	$I_C=50\text{mA}$, $I_E=0$	60			V
Collector Cut-Off Current	I_{CBO}	$V_{CB}=60\text{V}$, $I_E=0$			100	μA
Emitter Cut-Off Current	I_{EBO}	$V_{EB}=7\text{V}$, $I_C=0$			100	μA
Collector-Emitter Saturation Voltage	$V_{CE(SAT)}$	$I_C=3\text{A}$, $I_B=300\text{mA}$			1	V
Base-Emitter Saturation Voltage	$V_{BE(ON)}$	$V_{CE}=5\text{V}$, $I_C=500\text{mA}$			1	V
DC Current Gain	h_{FE}	$I_C=500\text{mA}$, $V_{CE}=5\text{V}$	100		200	
Current gain bandwidth product	f_T	$V_{CE}=5\text{V}$, $I_C=500\text{mA}$		3		MHZ

TYPICAL CHARACTERISTICS

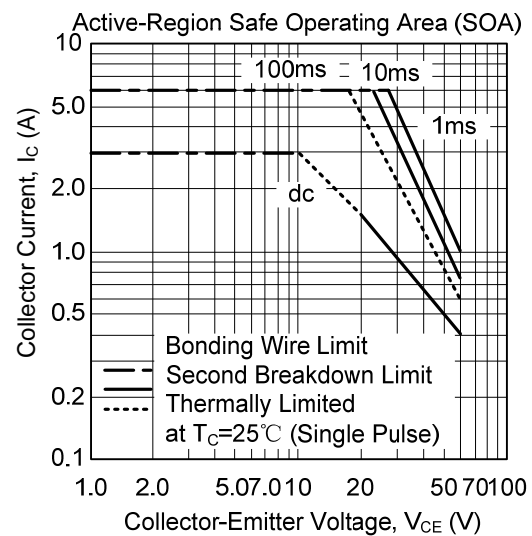
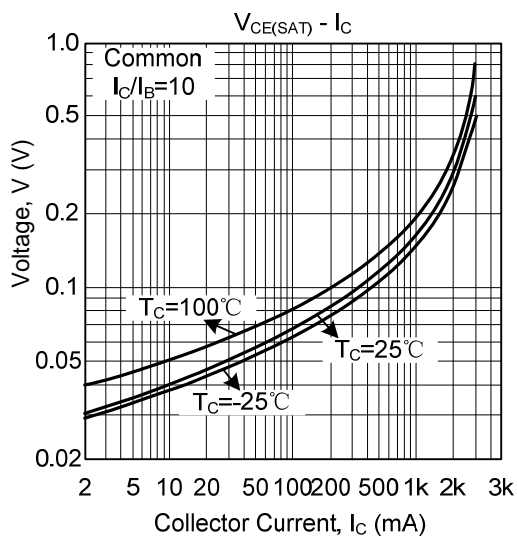
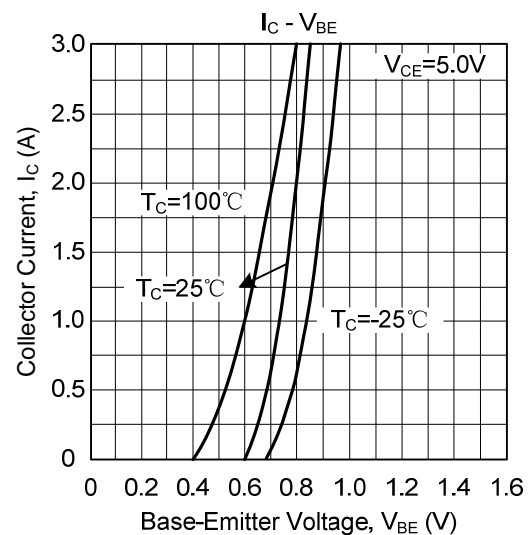
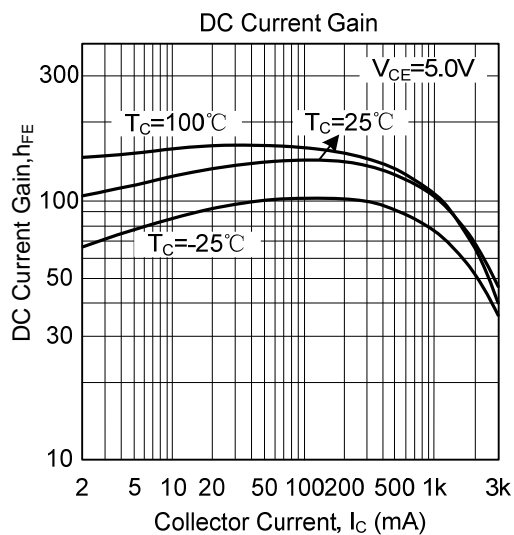
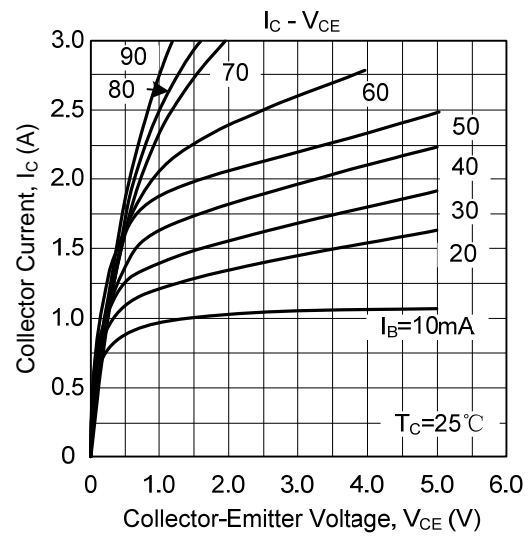
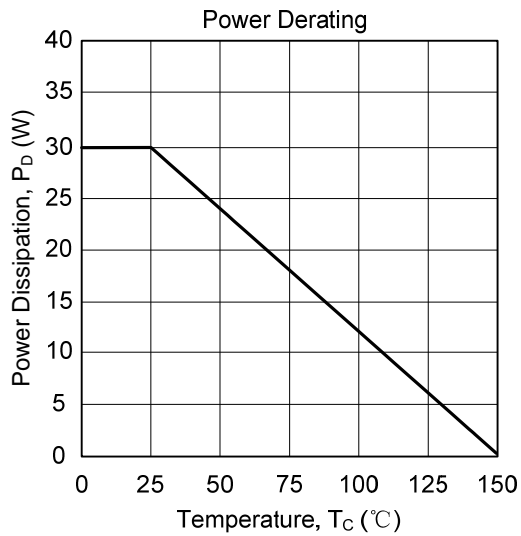

UTC assumes no responsibility for equipment failures that result from using products at values that exceed, even momentarily, rated values (such as maximum ratings, operating condition ranges, or other parameters) listed in products specifications of any and all UTC products described or contained herein. UTC products are not designed for use in life support appliances, devices or systems where malfunction of these products can be reasonably expected to result in personal injury. Reproduction in whole or in part is prohibited without the prior written consent of the copyright owner. The information presented in this document does not form part of any quotation or contract, is believed to be accurate and reliable and may be changed without notice.