

# AN6550

## Dual Operational Amplifier

### Overview

The AN6550 is a dual operational amplifier with a phase compensation circuit built-in, allowing low voltage operation.

It is suitable for application to various electronic circuits such as active filters and audio preamplifiers.

### Features

- Phase compensation circuit
- High voltage gain, low noise
- Output short protection circuit
- Low voltage operation( $\pm 2.5V$  to  $\pm 10V$ )

### Pin Descriptions

Pin No.	Pin name
1	Ch.1 output
2	External bias
3	Ch.1 inverting input
4	Ch.1 non inverting input
5	$V_{EE}$ (GND)
6	Ch.2 non inverting input
7	Ch.2 inverting input
8	Ch.2 output
9	$V_{CC}$

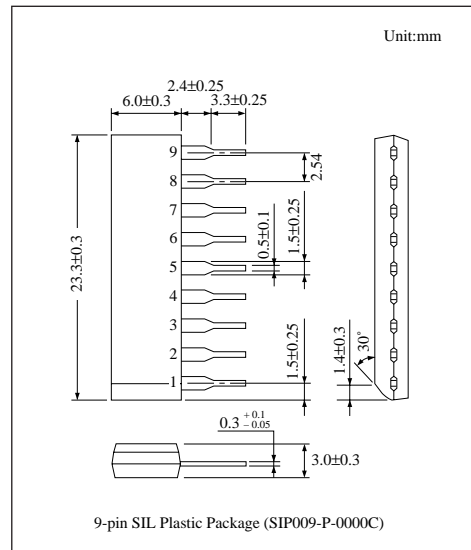

### Block Diagram

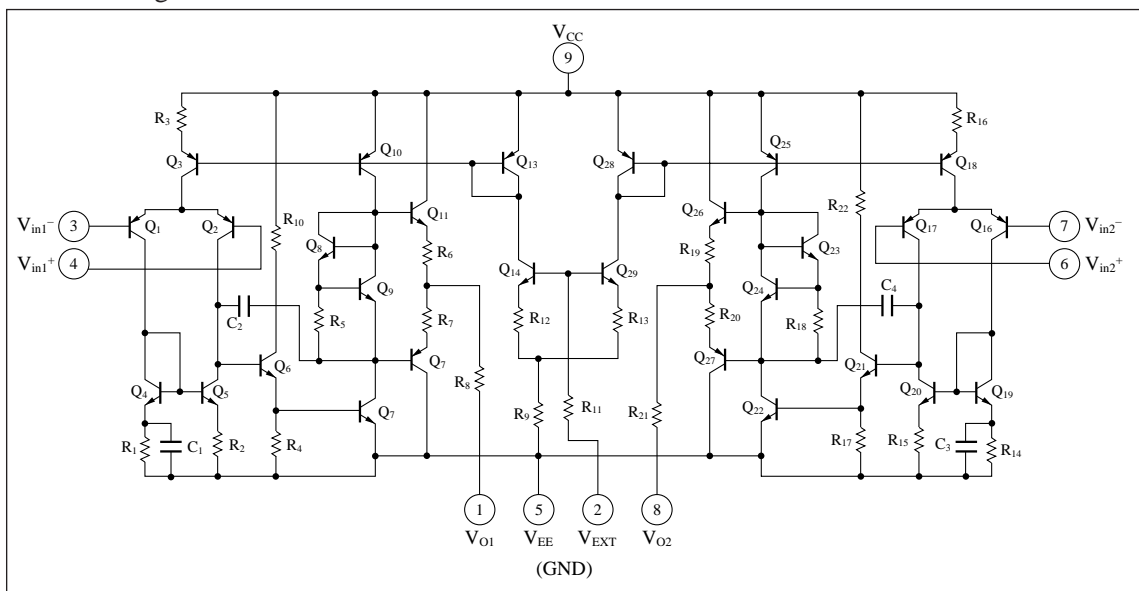

## ■ Absolute Maximum Ratings (Ta=25°C)

Parameter		Symbol	Rating	Unit
Voltage	Supply voltage	$V_{CC}, V_{EE}$	$\pm 12$	V
	External bias supply voltage	$V_{EXT}$	$V_{EE}$ to $V_{CC}$	V
	Differential input voltage	$V_{ID}$	$\pm 24$	V
	Common-mode input voltage	$V_{ICM}$	$\pm 12$	V
Power dissipation		$P_D$	500	mW
Temperature	Operating ambient temperature	$T_{opr}$	-20 to +75	°C
	Storage temperature	$T_{stg}$	-55 to +150	°C

## ■ Electrical Characteristics ( $V_{CC}=2.5V, V_{EE}=-2.5V, V_{EXT}=2.0V, Ta=25^\circ C$ )

Parameter	Symbol	Condition	min	typ	max	Unit
Input offset voltage	$V_{I(offset)}$	$R_S \leq 10k\Omega$	—	1.5	6	mV
Input offset current	$I_{IO}$		—	5	200	nA
Input bias current	$I_{Bias}$		—	150	500	nA
Voltage gain	$G_V$	$R_L \geq 2k\Omega$	65	100	—	dB
Maximum output voltage	$V_{O(max)}$	$R_L \geq 10k\Omega$	$\pm 1.2$	$\pm 1.7$	—	V
		$R_L \geq 2k\Omega$	$\pm 1$	$\pm 1.5$	—	V
Common-mode input voltage width	$V_{CM}$		$\pm 1$	$\pm 1.5$	—	V
Common-mode rejection ratio	CMR		70	80	—	dB
Supply voltage rejection ratio	SVR		—	100	300	$\mu V/V$
Power consumption	$P_C$	$R_L = \infty$	—	8	15	mW
Slew rate	SR	$R_L \geq 2k\Omega$	—	0.8	—	V/ $\mu s$
Equivalent input noise voltage	$V_{ni}$	$R_S = 1k\Omega, B = 10Hz$ to 30kHz	—	2.5	—	$\mu V_{rms}$

## ■ Pin Assignments

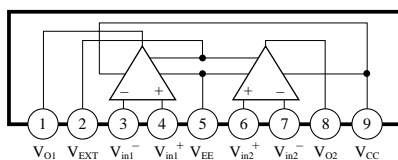

## ■ Characteristics Curve

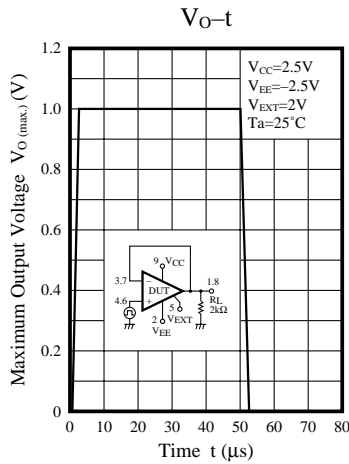
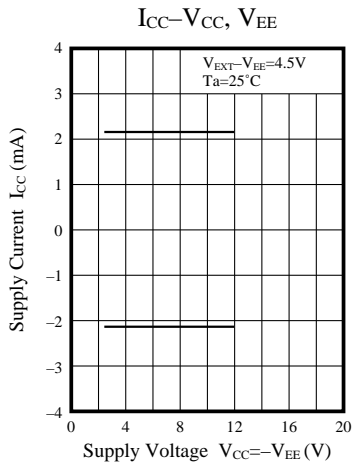
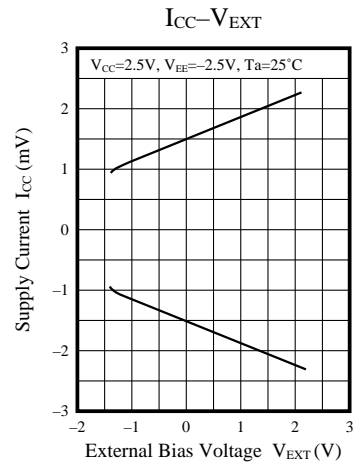
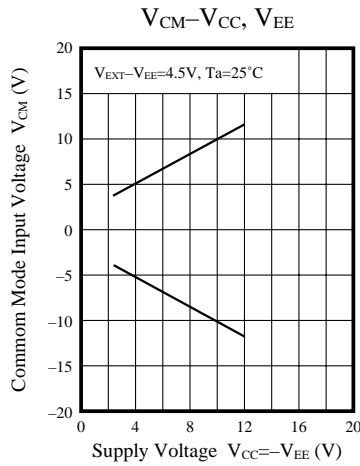
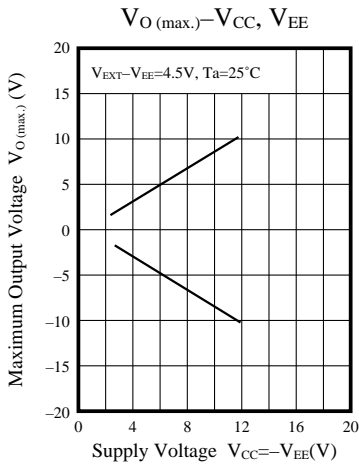
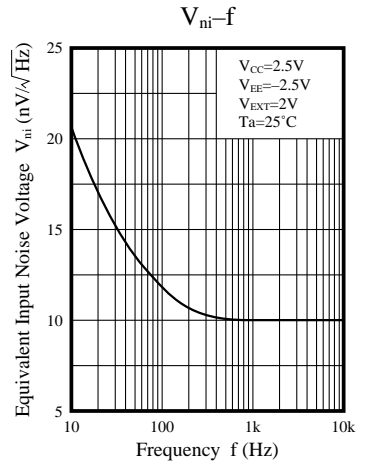
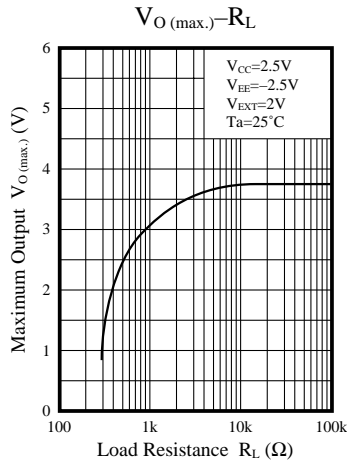
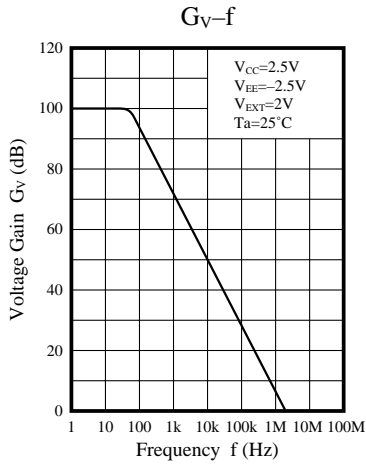

■ Application Circuit

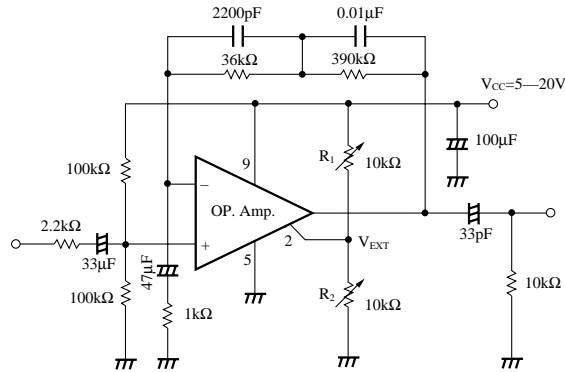

RIAA Pre-amplifier (single power supply operation)

Note)  $R_1$  and  $R_2$  are resistances for setting operational amplifier bias.

Set  $R_1$  and  $R_2$  so that  $V_{EXT}=2.0V$  to  $6.0V$ .

(Recommended Voltage  $V_{EXT}=4.5V$ )

■ How to Apply External to the AN6550

1. The AN6550 is an operational amplifier with a phase compensation circuit built-in, allowing low voltage operation, and its current consumption and bandwidth can be changed by applying external bias to it.
2. As shown below, applies bias voltage to 2  $V_{EXT}$  pin of the AN6550 allows the AN6550 to be handled in the very same way as the AN6551, except for pin connection.

Set  $V_{EXT} \geq V_{EE} + 1V$ .

1 ) By diode

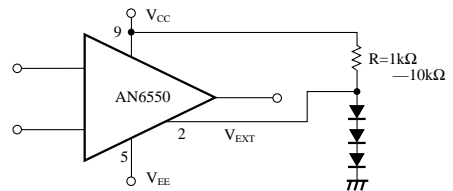

2 ) By connecting  $V_{EXT}$  pin to GND

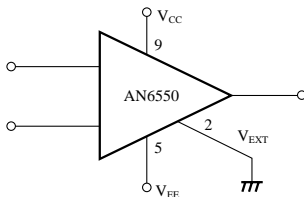

3 ) By dividing with resistors

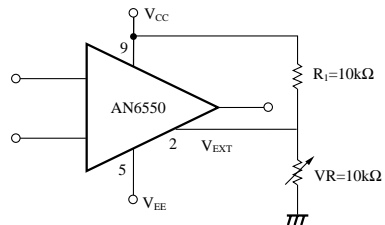

4 ) By Zener diode

( $V_{CC} - V_{EE} \geq 6V$ )

