

1W Isolated DC-DC converter
Fixed input voltage, unregulated single output



FEATURES

- Continuous short-circuit protection
- No-load input current as low as 8mA
- Operating ambient temperature range: -40°C to +105°C
- High efficiency up to 85%
- Compact SMD package
- I/O isolation test voltage: 1.5k VDC
- Industry standard pin-out

UL62368-1 EN62368-1 BS EN62368-1 IEC 62368-1

B_XT-1WR3 series are specially designed for applications where an isolated voltage is required in a distributed power supply system. They are suitable for: pure digital circuits, low frequency analog circuits, relay-driven circuits and data switching circuits.

Selection Guide

Certification	Part No.	Input Voltage (VDC)	Output		Full Load Efficiency (%) Min./Typ.	Capacitive Load(μF) Max.
		Nominal (Range)	Voltage (VDC)	Current (mA) Max./Min.		
--	B1203XT-W2R3	12 (10.8-13.2)	3.3	76/7	60/66	2400
EN/BS EN	B1203XT-1WR3		3.3	303/30	72/76	2400
UL/EN/BS EN/IEC	B1205XT-1WR3		5	200/20	78/82	2400
	B1209XT-1WR3		9	111/12	79/83	1000
	B1212XT-1WR3		12	84/9	79/83	560
	B1215XT-1WR3		15	67/7	79/83	560
	B1224XT-1WR3		24	42/4	81/85	220
EN/BS EN	B1509XT-1WR3	15 (13.5-16.5)	5	200/20	78/82	2400
UL/EN/BS EN/IEC	B1515XT-1WR3		9	111/12	78/82	1000
EN/BS EN	B1515XT-1WR3	15	67/7	79/83	560	
EN/BS EN	B2403XT-1WR3	24 (21.6-26.4)	3.3	303/30	72/76	2400
UL/EN/BS EN/IEC	B2405XT-1WR3		5	200/20	74/80	2400
	B2409XT-1WR3		9	111/12	74/80	1000
	B2412XT-1WR3		12	84/9	74/80	560
	B2415XT-1WR3		15	67/7	74/80	560
	B2424XT-1WR3		24	42/4	74/80	220

Input Specifications

Item	Operating Conditions		Min.	Typ.	Max.	Unit
Input Current (full load / no-load)	12VDC input	3.3V/5VDC output	--	102/8	107/--	mA
		9VDC/12VDC/15VDC output	--	101/8	106/--	
		24VDC output	--	99/8	103/--	
	15VDC input	5VDC/9VDC output	--	82/8	86/--	
		15VDC output	--	81/8	85/--	
	24VDC input	3.3V/5VDC output	--	53/8	57/--	
9VDC/12VDC/15VDC output		--	51/8	55/--		
24VDC output		--	53/8	57/--		
Reflected Ripple Current*			--	15	--	

Surge Voltage(1sec. max.)	12VDC input	-0.7	--	18	VDC
	15VDC input	-0.7	--	21	
	24VDC input	-0.7	--	30	
Input Filter		Capacitance filter			
Hot Plug		Unavailable			

Note: * Refer to DC-DC Converter Application Notes for detailed description of reflected ripple current test method.

Output Specifications

Item	Operating Conditions		Min.	Typ.	Max.	Unit
Voltage Accuracy			See output regulation curves (Fig. 1)			
Linear Regulation	Input voltage change: ±1%	3.3VDC output	--	--	1.5	--
		Others	--	--	1.2	
Load Regulation	10%-100% load	3.3V/5VDC output	--	5	15	%
		9VDC output	--	3	10	
		12VDC output	--	3	10	
		15VDC output	--	3	10	
		24VDC output	--	2	10	
Ripple & Noise*	20MHz bandwidth	3.3V/5VDC/9VDC/12VDC /15VDC output	---	30	75	mVp-p
		24VDC output	---	50	100	
Temperature Coefficient	Full load		--	±0.02	--	%/°C
Short-Circuit Protection			Continuous, self-recovery			

Note:* The "parallel cable" method is used for Ripple and Noise test, please refer to DC-DC Converter Application Notes for specific information.

General Specifications

Item	Operating Conditions	Min.	Typ.	Max.	Unit
Isolation	Input-output electric strength test for 1 minute with a leakage current of 1mA max.	1500	--	--	VDC
Insulation Resistance	Input-output resistance at 500VDC	1000	--	--	MΩ
Isolation Capacitance	Input-output capacitance at 100kHz/0.1V	--	20	--	pF
Operating Temperature	Derating when operating temperature ≥ 100°C, (see Fig. 2)	-40	--	105	°C
Storage Temperature		-55	--	125	
Case Temperature Rise	Ta=25°C	--	25	--	
Storage Humidity	Non-condensing	5	--	95	%RH
Reflow Soldering Temperature*		Peak temp. ≤ 245°C, maximum duration time ≤ 60s over 217°C			
Vibration		10-150Hz, 5G, 0.75mm. along X, Y and Z			
Switching Frequency	Full load, nominal input voltage	--	260	--	kHz
MTBF	MIL-HDBK-217F@25°C	3500	--	--	k hours
Moisture Sensitivity Level (MSL)	IPC/JEDEC J-STD-020D.1	Level 1			

Note: *Please refer to IPC/JEDEC J-STD-020D.1.

Mechanical Specifications

Case Material	Black plastic; flame-retardant and heat-resistant (UL94V-0)
Dimensions	13.20 x 11.40 x 7.25 mm
Weight	1.4g(Typ.)
Cooling Method	Free air convection

Electromagnetic Compatibility (EMC)

Emissions	CE	CISPR32/EN55032	CLASS B
	RE	CISPR32/EN55032	CLASS B
Immunity	ESD	IEC/EN61000-4-2	Air ±8kV, Contact ±6kV perf. Criteria B

Note: Refer to Fig. 4 for recommended circuit test.

Typical Performance Curves

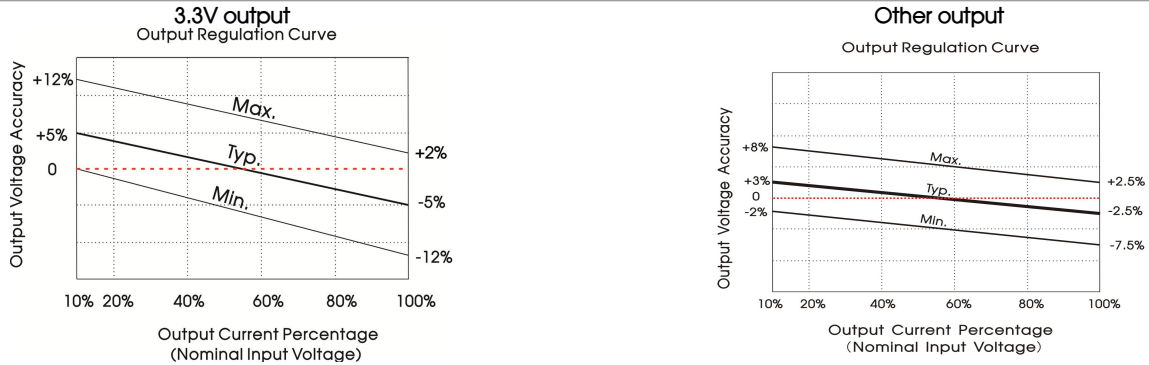

Fig. 1

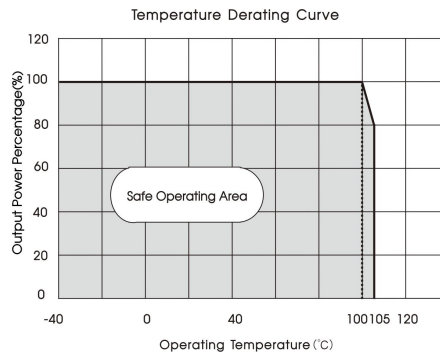
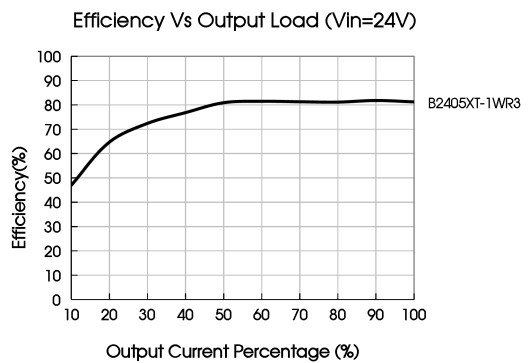
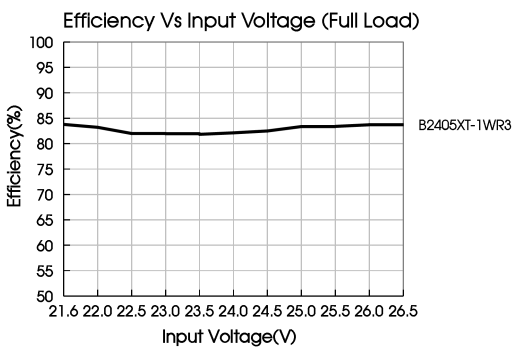
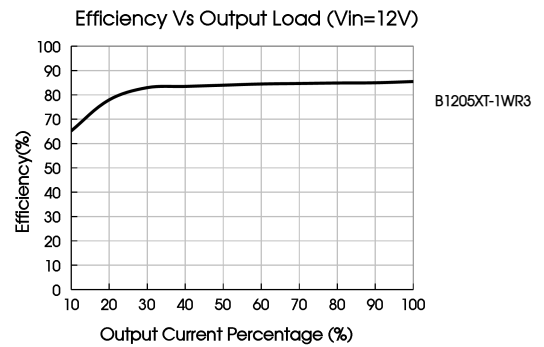
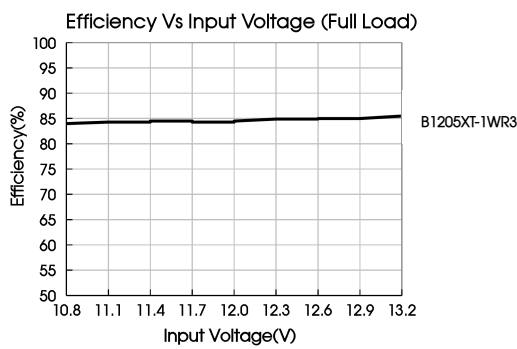

Fig. 2



Design Reference

1. Typical application

Input and/or output ripple can be further reduced, by connecting a filter capacitor from the input and/or output terminals to ground as shown in Fig. 3.

Choosing suitable filter capacitor values is very important for a smooth operation of the modules, particularly to avoid start-up problems caused by capacitor values that are too high. For recommended input and output capacitor values refer to Table 1.

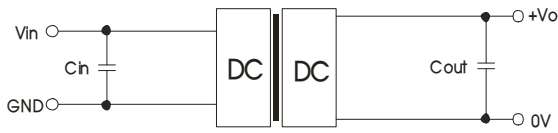

Fig. 3

Table 1: Recommended input and output capacitor values

Vin	Cin	Vo	Cout
12VDC	2.2μF/25V	3.3V/5VDC	10μF/16V
15VDC	2.2μF/25V	9VDC	2.2μF/16V
24VDC	1μF/50V	12VDC	2.2μF/25V
--	--	15VDC	1μF/25V
--	--	24VDC	1μF/50V

2. EMC compliance circuit

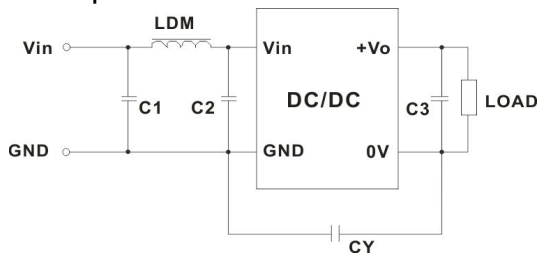

Fig. 4

Table 2: EMC recommended circuit value table

Emissions	C1/C2	4.7μF /50V
	CY	270pF /2kV
	C3	Refer to the Cout in table 1
	LDM	6.8μH

3. For additional information please refer to DC-DC converter application notes on www.mornsun-power.com

Dimensions and Recommended Layout

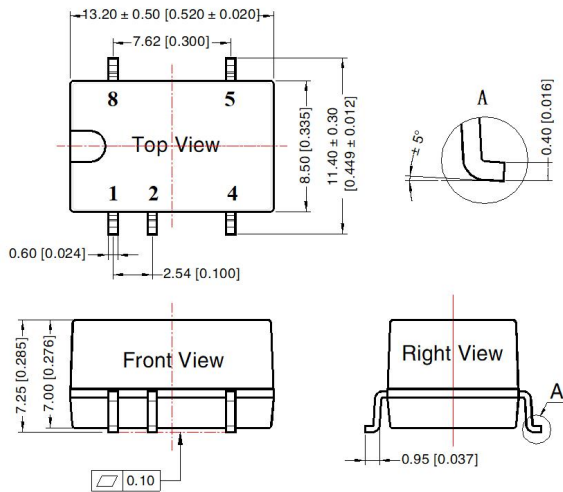

Note:
Unit: mm[inch]
Pin section tolerances: ± 0.10 [± 0.004]
General tolerances: ± 0.25 [± 0.010]

THIRD ANGLE PROJECTION

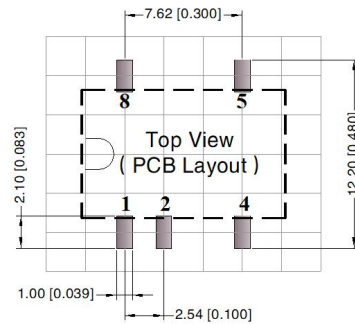

Note: Grid 2.54*2.54mm

Pin-Out	
Pin	Mark
1	GND
2	Vin
4	0V
5	+Vo
8	NC

NC: Pin to be isolated from circuitry

Tape and Reel Info

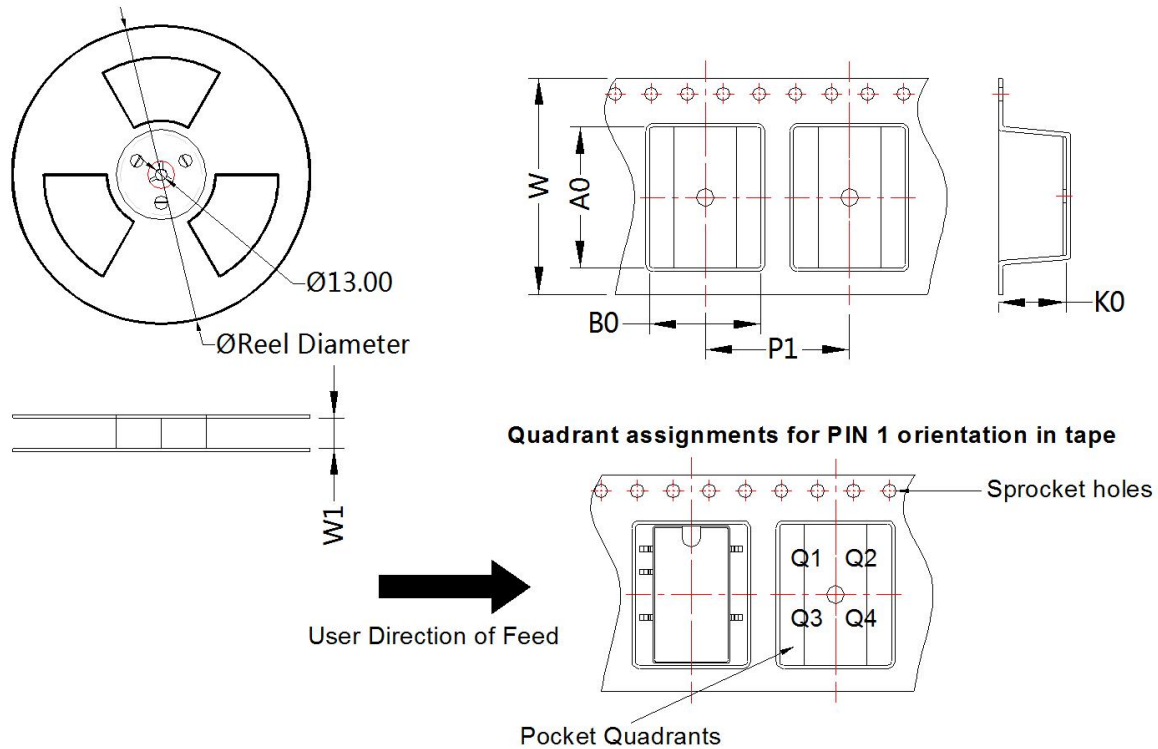

Device	Package Type	Pin	SPQ	Reel Diameter (mm)	Reel Width W1 (mm)	A0 (mm)	B0 (mm)	K0 (mm)	P1 (mm)	W (mm)	Pin1 Quadrant
B_XT-1WR3	SMD	5	500	330.0	24.5	13.4	11.7	7.5	16.0	24.0	Q1

Notes:

1. For additional information on Product Packaging please refer to www.mornsun-power.com. Tube Packaging bag number: 58210024, Roll Packaging bag number: 58200054;
2. If the product is not operated within the required load range, the product performance cannot be guaranteed to comply with all parameters in the datasheet;
3. The maximum capacitive load offered were tested at input voltage range and full load;
4. Unless otherwise specified, parameters in this datasheet were measured under the conditions of Ta=25°C, humidity<75%RH with nominal input voltage and rated output load;
5. All index testing methods in this datasheet are based on our company corporate standards;
6. We can provide product customization service, please contact our technicians directly for specific information;
7. Products are related to laws and regulations: see "Features" and "EMC";
8. Our products shall be classified according to ISO14001 and related environmental laws and regulations, and shall be handled by qualified units.

MORNSUN Guangzhou Science & Technology Co., Ltd.

Address: No. 5, Kehui St. 1, Kehui Development Center, Science Ave., Guangzhou Science City, Huangpu District, Guangzhou, P. R. China
Tel: 86-20-38601850 Fax: 86-20-38601272 E-mail: info@mornsun.cn www.mornsun-power.com