

## Data Sheet DHT20

### Humidity and Temperature Module

- Relative humidity and temperature output
- Superior sensor performance, typical accuracy RH:  $\pm 3\%$ , T:  $\pm 0.5^{\circ}\text{C}$
- Fully calibrated and processed digital output, I<sup>2</sup>C protocol
- Wide voltage support 2.2 to 5.5V DC
- Excellent long-term stability
- Fast-response and anti-interference capability

#### Product Summary

DHT20 is a new upgraded product of DHT11, equipped with a dedicated ASIC sensor chip, a high-performance semiconductor silicon-based capacitive humidity sensor and a standard on-chip temperature sensor, and uses a standard I<sup>2</sup>C data output signal format. Its performance has been greatly improved and has exceeded the reliability level of the previous generation sensor(DHT11).The new generation of upgraded products have been improved to make their performance more stable in high temperature and high humidity environments; at the same time, the accuracy, response time, and measurement range of the product have been greatly improved. Each sensor is rigorously calibrated and tested before leaving the factory to ensure and satisfy customer's large-scale applications.

## 1 Product Description

The DHT20 is a kind of sensor of humidity and temperature with digital I<sup>2</sup>C output. It can be applied to HVAC, dehumidifier, testing and inspection equipment, consumer products, automobiles, automatic control, data loggers, weather stations, home appliances, humidity control, medical and other application fields which need to detect and control temperature and humidity.

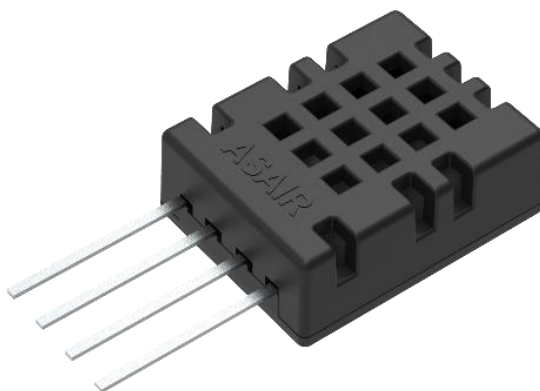

Figure 1. DHT20

## 2 Sensor Specifications

### Relative Humidity

Parameter	Condition	Min	Typical Value	Max	Unit
Resolution	Typical	-	0.024	-	%RH
Accuracy Tolerance <sup>1</sup>	Typical	-	±3	-	%RH
	Max	See Figure 2		-	%RH
Repeatable	-	-	±0.1	-	%RH
Hysteresis	-	-	±1	-	%RH
Nonlinear	-	-	<0.1	-	%RH
Response Time <sup>2</sup>	$\tau$ 63%	-	<8	-	s
Scope of Work	Extended <sup>3</sup>	0	-	100	%RH
Prolonged Drift <sup>4</sup>	Normal	-	<0.5	-	%RH/yr

Table 1. Humidity characteristics table

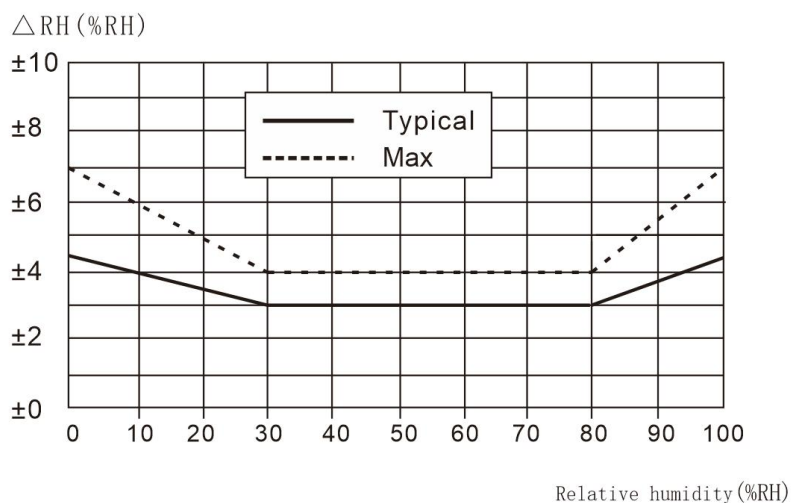

Figure 2. Typical and maximum humidity errors

### Electrical Specifications

Parameter	Condition	Min	Typical Value	Max	Unit
Supply Voltage	Typical	2.2	3.3	5.5	V
Supply Current, $I_{DD}$ <sup>5</sup>	Dormancy	-	250	-	nA
	Measure	-	980	-	μA
Power Consumption <sup>6</sup>	Dormancy	-	-	0.8	μW
	Measure	-	3.2	-	mW
Communication	Standard I <sup>2</sup> C protocol				

Table 2. Electrical Specifications

Temperature

Parameter	Condition	Min	Typical Value	Max	Unit
Resolution	Typical	-	0.01	-	°C
Accuracy	Typical	-	±0.5	-	°C
Tolerance <sup>1</sup>	Max	See Figure 3		-	°C
Repeatable	-	-	±0.1	-	°C
Hysteresis	-	-	±0.1	-	°C
Response Time <sup>2</sup>	$\tau$ 63%	5	-	30	°C
Scope of Work	Extended <sup>3</sup>	-40	-	80	°C
Prolonged Drift <sup>4</sup>	Normal	-	<0.04	-	°C /yr

Table 3. Temperature characteristics table

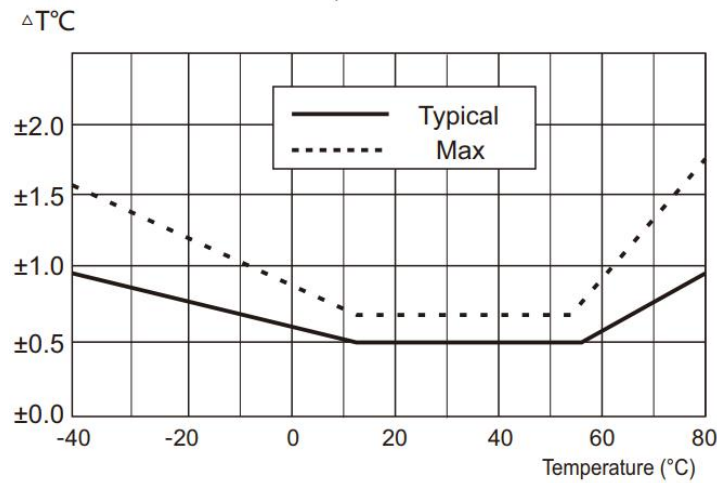

Figure 3. Typical and maximum temperature errors

Package information

Sensor model	Package	Quantity
DHT20	Pallet packaging	100PCS/Pallet(MAX)

Table 4. Package information

1. This accuracy is based on the sensor's test accuracy at a supply voltage of 3.3V at 25°C during the factory inspection. This value does not include hysteresis and non-linearity and applies only to non-condensing conditions.  
 2. The time required to reach the first-order response of 63% at 25°C and 1 m/s airflow.  
 3. Normal operating humidity range: 0-80%RH. There will be deviation in the sensor reading (after 60 hours in 90%RH humidity, drift >3%RH)

beyond this range. The working condition is limited to -40°C -80°C.  
 4. Output signal may be high if the sensor is surrounded by volatile solvents, offensive odor tapes, adhesives, and packaging materials. Please refer to the relevant documentation for detailed instructions.  
 5. The minimum and maximum values for supply current and power consumption are based on VCC = 3.3V and T < 60°C.  
 6. The response time depends on the thermal conductivity of the substrate of the sensor.

### 3 Expansion Performance

#### 3.1 Operating Conditions

The performance of the sensor is stable within the recommended working condition shown in figure 4. Long-term exposure to the condition that outside of the normal range of conditions, especially humidity is over 80%, may cause the output signal temporary drift (drift + 3% RH after 60 hours). After returning to the normal working condition, the sensor will slowly recover to the calibration status. Refer to "Recovery Processing" in section 4.3 to accelerate the recovery process. Long-term operating under the abnormal conditions will accelerate the aging of the sensor.

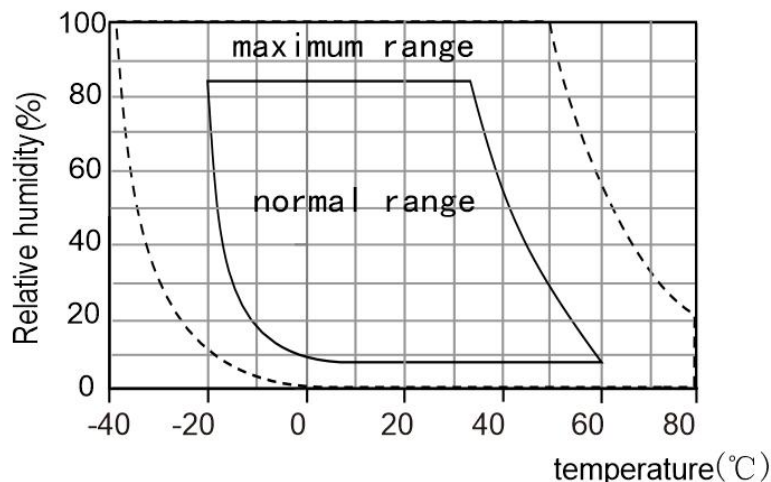

Figure 4. Working conditions

#### 3.2 RH Accuracy at Different Temperatures

Figure 2 defines the RH accuracy at 25°C, and Figure 5 shows the typical humidity error for other temperature ranges.

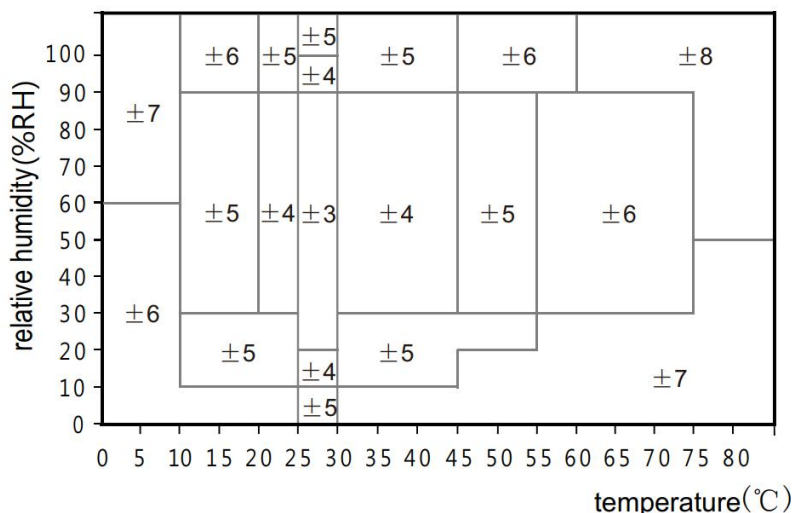

Figure 5. The typical error of humidity in the range of 0~80°C, unit: (%RH)

Please note: The above error is the typical error (excluding hysteresis) of the reference instrument test with a high-precision dew point meter.

### 3.3 Electrical Characteristics

The power consumption given in Table 2 is related to temperature and supply voltage VDD. Refer to Figures 6 and 7 for power consumption estimation. The curves in Figures 6 and 7 are typical natural characteristics, and there may be deviations.

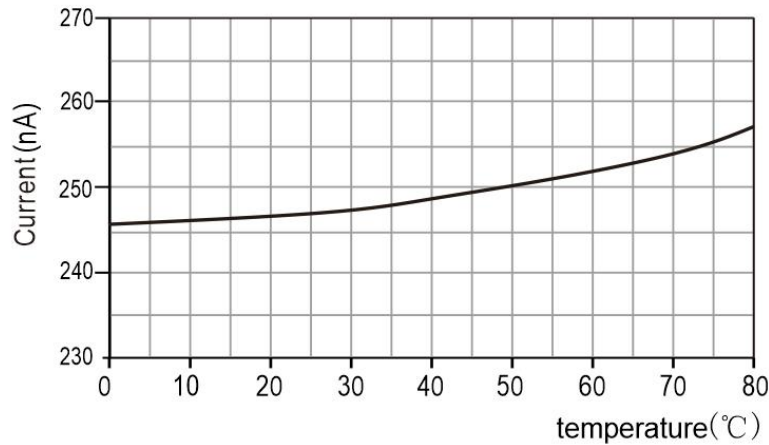

Figure 6. Typical supply current vs. temperature curve (sleep mode) when VDD=3.3V

Please note: There is a deviation of approximately ±25% between these data and the displayed value.

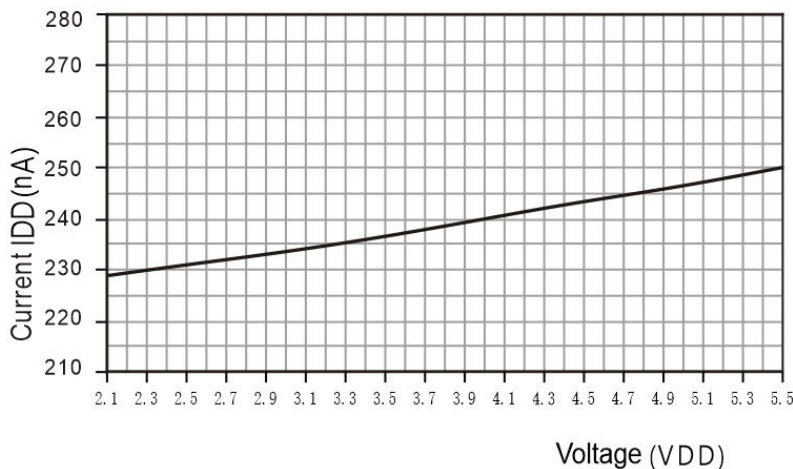

Figure 7. The relationship between current and voltage at 25°C

Please note: The deviation of these data from the displayed value may reach ±50% of the displayed value. At 60°C, the coefficient is about 15 (Compared with table 2).

## 4 Applications

### 4.1 Welding Instructions

It is forbidden to use reflow soldering or wave soldering for soldering. The manual soldering must be contacted for less than 5 seconds at the highest temperature of 300°C.

Note: After welding, DHT20 need to be stored in the condition >75%RH for over 12 hours to ensure the rehydration of the polymer. Otherwise, the output signal of the sensor will drift. The sensor can also be placed in a natural environment (>40%RH) for more than 2 days to rehydrate it. The use of low temperature solder (for example: 180°C) can reduce the hydration time.

Do not use the sensor in corrosive gas or condensed water.

## 4.2 Storage Conditions and Operating Instructions

The level of the humidity sensitivity (MSL) is 1, according to the IPC/JEDEC J-STD-020 standard. Therefore, it is recommended to use it within one year after shipment.

This kind of the sensor is not an ordinary electronic component and needs to be carefully protected. Users must pay more attention to this key point. Long-term exposure to high concentrations of chemical vapor will cause the output signal of the sensor drift. Therefore, it is recommended to store the sensor in the original packaging including a sealed ESD bag, and meet the following conditions: temperature range 10°C - 50°C (a limited time within 0-85°C); humidity 20-60%RH (the sensor without ESD package). For those sensors which had been removed from the original packaging, we recommend to store them in an antistatic bag made of PET/AL/CPE containing metal.

During production and transportation, the sensor should be avoided to contact with high concentrations of chemical solvents and long-term exposure in the air. It should avoid to contact with volatile glues, tapes, stickers or volatile packaging materials, such as foam foils and foam materials, etc. The area of production should be well ventilated.

## 4.3 Recovery Processing

As mentioned above, if the sensor had been exposed to extreme working conditions or chemical vapors, the output signal will drift. It can be restored to the calibration state by the following processing.

Drying: Keep for 6 hours under 60-65°C and <5%RH humidity conditions;

Rehydration: Keep for 6 hours under 20-30°C and >75%RH humidity conditions<sup>7</sup>.

## 4.4 Temperature Effect

The relative humidity of the gas depends to a large extent on the temperature. Therefore, it is necessary to ensure that all sensors measuring the same humidity operate at the same condition of temperature. It should make sure that the tested sensor and the reference sensor are at the same conditions when operate the test, and then compare the output signals.

In addition, when the measurement is at high frequency, the temperature of the sensor will rise, so it will affect the accuracy. If you want to ensure the variation of the temperature of the sensor is less than 0.1°C, the activation time of DHT20 should not exceed 10% of the measurement time. It is recommended to measure the data every 2 seconds.

## 4.5 Materials for Sealing and Encapsulation

Many materials can absorb moisture and will act as a buffer, which will increase the time of response and lag. Therefore, the materials around the sensors should be carefully selected. The recommended materials are: metal materials, LCP, POM(Delrin), PTFE(Teflon), PE, PEEK, PP, PB, PPS, PSU, PVDF, PVF.

Material used for sealing and bonding (conservative recommendation): It is recommended to use epoxy resin or silicone resin to encapsulate electronic components. The gases released by these materials may also contaminate DHT20 (see 4.2). Therefore, the sensor should be assembled last, and stored in a well-ventilated place, or dried for 24 hours in an environment of >50°C, so as to release the polluted gas before packaging.

## 4.6 Wiring Rules and Signal Integrity

If the signal lines of SCL and SDA are parallel and very close to each other, it may cause signal crosstalk and communication failure. The solution is to place VDD and/or GND between the two signal lines, separate the signal lines, and use shielded cables. In addition, reduce SCL frequency may also improve the integrity of signal transmission. A 100nF decoupling capacitor must be added between the power supply pins (VDD, GND) for filtering. This capacitor should be as close as possible to the sensor. See the next chapter.

---

<sup>7</sup>75%RH can be easily generated from saturated NaCl.

### 5 Interface Definition

Pins	Name	Describe
1	VDD	Power supply(2.2v to 5.5v)
2	SDA	Serial Data Bidirectional port
3	GND	Ground
4	SCL	Serial clock Bidirectional port

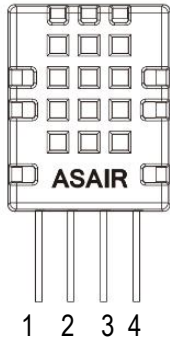

Table 5. ATH21B pin distribution (top view)

#### 5.1 Power Pin(VDD,GND)

The power supply range of DHT20 is 2.2-5.5V.

#### 5.2 Serial Clock SCL

The serial clock is used to synchronize the communication between the microprocessor and DHT20. Since the interface contains completely static logic, there is no minimum SCL frequency.

#### 5.3 Serial Data SDA

The SDA pin is used for data input and output of the sensor. When sending a command to the sensor, SDA is valid on the rising edge of the serial clock (SCL), and when SCL is high, SDA must remain stable. After the falling edge of SCL, the SDA value can be changed. To ensure communication safety, the effective time of SDA should be extended by  $T_{SU}$  and  $T_{HO}$  before the rising edge and after the falling edge of SCL refer to Figure 9. When reading data from the sensor, SDA is valid (TV) after SCL goes low, and is maintained until the next falling edge of SCL.

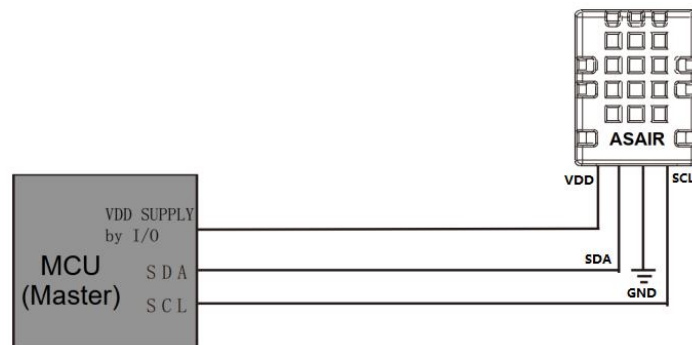

Figure 8. Typical application circuit

Note:

1. The power supply voltage of the host MCU must be consistent with the sensor when the product is used in the circuit.
2. If you need to further improve the reliability of the system, you can control the sensor power supply.
3. When the sensor is just powered on, give priority to the sensor VDD power supply, SCL and SDA high level can be set after 5ms.

To avoid signal conflicts, the microprocessor (MCU) must only drive SDA and SCL at low level. An external pull-up resistor (for example: 4.7kΩ) is required to pull the signal to a high level. The pull-up resistor has been included in the I/O circuit of the DHT20 microprocessor. Refer to Table 7 and Table 8 for detailed information about sensor input/output characteristics.

## 6 Electrical Characteristics

### 6.1 Absolute Maximum Ratings

The electrical characteristics of DHT20 are defined in Table 2. The absolute maximum ratings given in Table 6 are only stress ratings and provide more information. Under such condition, it is not advisable for the device to perform functional operations. Exposure to absolute maximum ratings for a long time may affect the reliability of the sensor.

Parameters	Min	Max	Unit
VDD to GND	-0.3	5.5	V
Digital I/O Pins (SDA, SCL) to GND	-0.3	VDD+0.3	V
Input current per pin	-10	10	mA

Table 6. Absolute maximum electrical ratings

ESD electrostatic discharge conforms to JEDECJESD22-A114 standard (human body model  $\pm 4kV$ ), JEDECJESD22-A115 (machine model  $\pm 200V$ ). If the test condition exceeds the nominal limit index, the sensor needs to add an additional protection circuit.

### 6.2 Input/Output Characteristics

Electrical characteristics, such as power consumption, input and output high and low voltages, etc., depend on the power supply voltage. In order to make the sensor communication smooth, it is very important to ensure that the signal design is strictly limited to the range given in Table 7, 8 and Figure 9).

Parameters	Conditions	Min	Typical	Max	Unit
Low output Voltage VOL	VDD=3.3V, -4mA<IOL<0mA	0	-	0.4	V
High output Voltage VOH	-	70% VDD	-	VDD	V
Output sink current IOL	-	-	-	-4	mA
Low output Voltage VIL	-	0	-	30%VDD	V
High output Voltage VIH	-	70% VDD	-	VDD	V
Input Current	VDD=5.5V, VIN=0Vto5.5V	-	-	$\pm 1$	$\mu A$

Table 7. DC characteristics of digital input and output pads, if there is no special statement VDD=2.2 V to 5.5 V; T=-40°C to 80°C

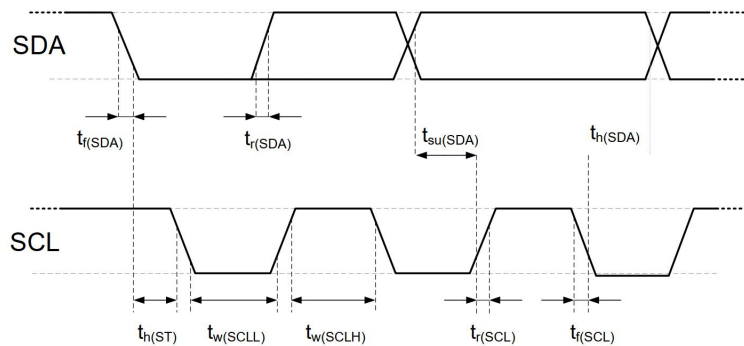

Figure 9. Timing diagram of digital input / output

The abbreviations are explained in Table 8. The thicker SDA line is controlled by the sensor, and the ordinary SDA line is controlled by the single-chip microcomputer. Please note that the SDA valid read time is triggered by the falling edge of the previous conversion.



Symbol	Parameter	I <sup>2</sup> C Standard Mode		I <sup>2</sup> C Fast Mode		Unit
		Min	Max	Min	Max	
f(SCL)	SCL clock frequency	0	100	0	400	kHz
tw(SCLL)	SCL clock low time	4.7		1.3		μs
tw(SCLH)	SCL clock high time	4.0		0.6		μs
tsu(SDA)	SDA setup time	250		100		ns
th(SDA)	SDA data hold time	0.09	3.45	0.02	0.9	μs

Note: For both pins the measurements are from 0.2VDD and 0.8VDD.  
 Note: The above I2C timing sequence is determined by the following internal delays:  
 (1) The delay of the internal SDI input pin relative to the SCK pin, with a typical value of 100ns  
 (2) The internal SDI output pin has a time delay of the falling edge compared with SCK, with a typical value of 200ns

**Table 8.** Timing characteristics of I<sup>2</sup>C fast mode digital Inputs / outputs  
 The meaning is shown in Figure 9. Unless otherwise noted

## 7 Sensor Communication

DHT20 uses standard I<sup>2</sup>C protocol for communication. For information about the I<sup>2</sup>C protocol other than the following chapters, please refer to the following website: [www.aosong.com](http://www.aosong.com) provides a sample program for reference.

### 7.1 Start the Sensor

The first step is to power up the sensor with the selected VDD supply voltage (range between 2.2V and 5.5V). After power-on, the sensor needs less than 100ms stabilization time (SCL is high at this time) to reach the idle state and it is ready to receive commands sent by the host (MCU).

### 7.2 Start/Stop Sequence

Each transmission sequence starts with the Start state and ends with the Stop state, as shown in Figure 10 and Figure 11.

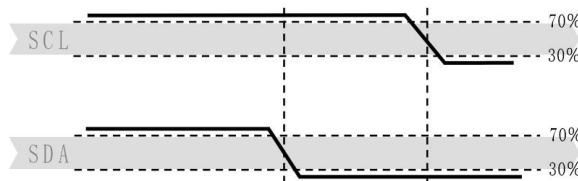

**Figure 10.** Start transmission status (S)

When SCL is high, SDA is converted from high to low. The start state is a special bus state controlled by the master, indicating the start of the slave transfer (after Start, the BUS is generally considered to be in a busy state).

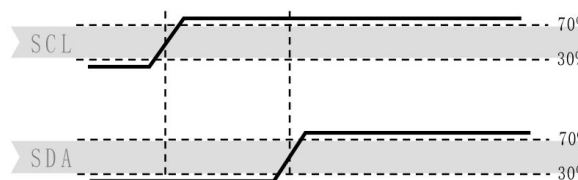
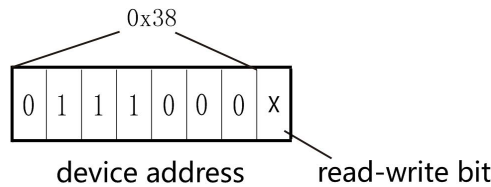

**Figure 11.** Stop transmission state (P)

When SCL is high, the SDA line changes from low to high. The stop state is a special bus state controlled by the master, indicating the end of the slave transmission (after Stop, the BUS is generally considered to be in an idle state).

### 7.3 Send Command

After the transmission is started, the first byte of I<sup>2</sup>C that is subsequently transmitted includes the 7-bit I<sup>2</sup>C device address 0x38 and a SDA direction bit x (read R: '1', write W: '0'). After the 8th falling edge of the SCL clock, pull down the SDA pin (ACK bit) to indicate that the sensor data is received normally. After sending the measurement command 0xAC, the MCU must wait until the measurement is completed.



Bits	Significance	Description
Bit[7]	Busy indication	1-Equipment is busy, in measurement mode 0- Equipment is idle, in hibernation state
Bit[6:5]	Retain	Retain
Bit[4]	Retain	Retain
Bit[3]	CAL Enable	1 - Calibrated 0 - Uncalibrated
Bit[2:0]	Retain	Retain

Table 9. Status bit description

### 7.4 Sensor Reading Process

1. After power-on, wait no less than 100ms. Before reading the temperature and humidity value, get a byte of status word by sending 0x71. If the status word and 0x18 are not equal to 0x18, initialize the 0x1B, 0x1C, 0x1E registers, details Please refer to our official website routine for the initialization process; if they are equal, proceed to the next step.

2. Wait 10ms to send the 0xAC command (trigger measurement). This command parameter has two bytes, the first byte is 0x33, and the second byte is 0x00.

3. Wait 80ms for the measurement to be completed, if the read status word Bit [7] is 0, it means the measurement is completed, and then six bytes can be read continuously; otherwise, continue to wait.

4. After receiving six bytes, the next byte is the CRC check data. The user can read it out as needed. If the receiving end needs CRC check, an ACK will be sent after the sixth byte is received. Reply, otherwise send NACK to end, the initial value of CRC is 0xFF, and the CRC8 check polynomial is:

$$CRC [7:0] = 1 + X^4 + X^5 + X^8$$

5. Calculate the temperature and humidity value

Note: The calibration status check in the first step only needs to be checked when the power is turned on. No operation is required during the acquisition process.

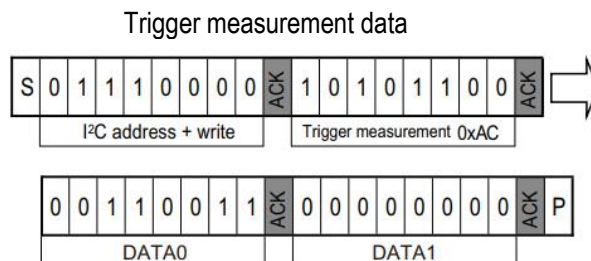

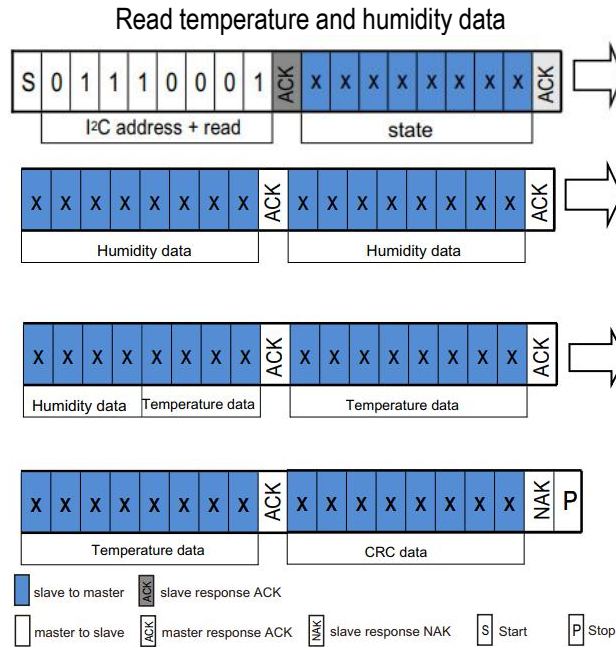

Note: The sensor needs time to collect. After the host sends a measurement command (0xAC), delay more than 80 milliseconds before reading the converted data and judging whether the returned status bit is normal. If the status bit [Bit7] is 0, it means that the data can be read normally. When it is 1, the sensor is busy, and the host needs to wait for the data processing to complete.

## 8 Signal Conversion

### 8.1 Relative Humidity Conversion

The relative humidity RH can be calculated according to the relative humidity signal  $S_{RH}$  output by SDA through the following formula (the result is expressed in %RH):

$$RH[\%] = \left(\frac{S_{RH}}{2^{20}}\right) * 100\%$$

### 8.2 Temperature Conversion

The temperature T can be calculated by substituting the temperature output signal  $S_T$  into the following formula: (The result is expressed in temperature  $^{\circ}C$ ):

$$T[^{\circ}C] = \left(\frac{S_T}{2^{20}}\right) * 200 - 50$$

## 9 Environmental Stability

If the sensor is used in equipment or machinery, make sure that the sensor used for measurement and reference-sense the same temperature and humidity. If the sensor is placed in the equipment, the response time will be prolonged, so ensure that sufficient measurement time is reserved in the program design. The DHT20 sensor is tested according to the company standard of the temperature and humidity sensor of Aosong. The performance of the sensor under other test conditions is not guaranteed and cannot be used as a part of the sensor's performance. Especially for specific occasions required by users, no promises are made.

## 10 Packing Instructions

### 10.1 Outer Dimensions

DHT20 uses pallet packaging, each tray packed with 50 sensors, each ten plastic tray attached to a vacant plastic tray as a sealing cover, that is, 11 plastic tray sealed in an anti-static shielding bag and packing, a total of 500

sensors. A package diagram with sensor positioning is shown in Figure 12. Blister tray is placed in an anti-static shielding bag.

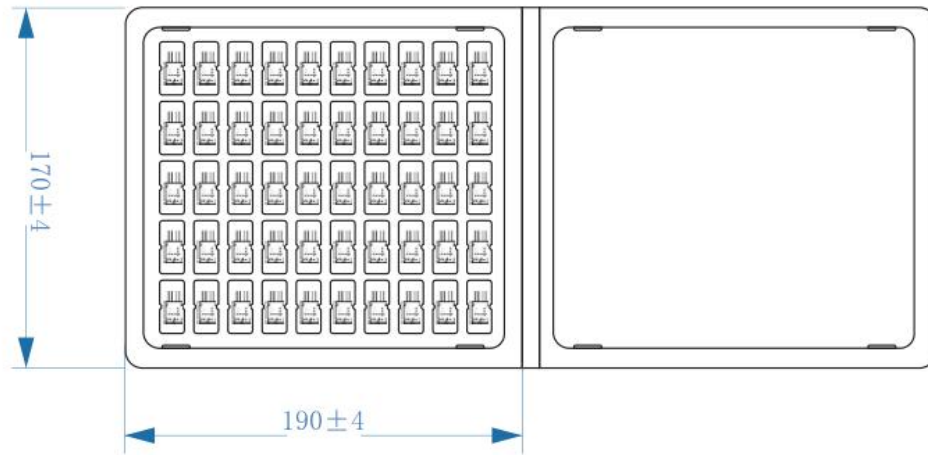

Figure 12. DHT20 sensor package diagram (unit: mm unmarked tolerance: ± 0.2mm)

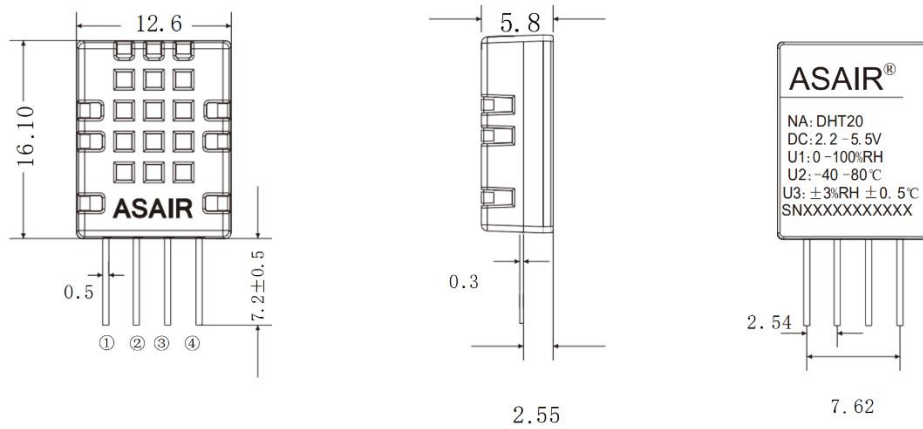

Figure 13. DHT20 sensor encapsulation (unit: mm not specified tolerance: ± 0.2 mm)

### 10.2 Tracking Information

All DHT20 sensors have laser marking on the surface, and are accompanied by markings for parameter descriptions, see Figure 14.

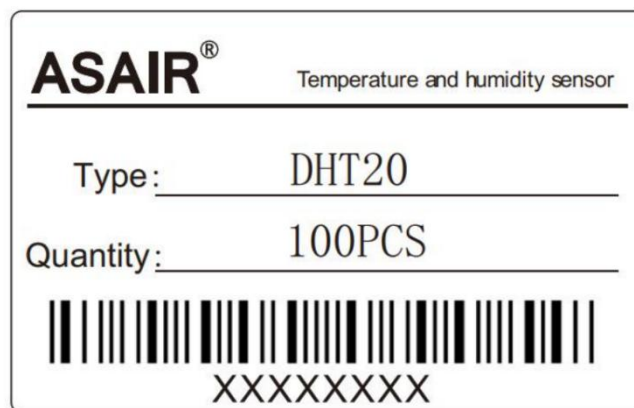

Figure 14. Sensor laser marking

# Important Notices

## Warning, Personal Injury

Do not apply this product to safety protection devices or emergency stop equipment, and any other applications that may cause personal injury due to the product's failure. Do not use this product unless there is a special purpose or use authorization. Refer to the product data sheet and application guide before installing, handling, using or maintaining the product. Failure to follow this recommendation may result in death and serious personal injury.

If the buyer intends to purchase or use Aosong products without obtaining any application licenses and authorizations, the buyer will bear all the compensation for personal injury and death arising therefrom, and exempt Aosong managers and employees and affiliated subsidiaries from this. Agents, distributors, etc. may incur any claims, including: various costs, compensation fees, attorney fees, etc.

## ESD Protection

Due to the inherent design of the component, it is sensitive to static electricity. In order to prevent the damage caused by static electricity or reduce the performance of the product, please take necessary anti-static measures when using this product.

## Quality Assurance

The company provides a 12-month (1 year) quality guarantee (calculated from the date of shipment) to direct purchasers of its products, based on the technical specifications in the product data manual published by Aosong. If the product is proved to be defective during the warranty period, the company will provide free repair or replacement. Users need to satisfy the following conditions:

- Notify our company in writing within 14 days after the defect is found.
  - The defect of this product will help to find out the deficiency in design, material and technology of our product.
  - The product should be sent back to our company at the buyer's expense.
  - The product should be within the warranty period.
- The company is only responsible for products that are defective when used in applications that meet the technical conditions of the product. The company does not make any guarantees, guarantees or written statements about the application of its products in those special applications. At the same time, the company does not make any promises about the reliability of its products when applied to products or circuits.

This manual may be changed at any time without notice.  
Copyright© 2021, **ASAIR®**