

LM160/LM360 High Speed Differential Comparator

General Description

The LM160/LM360 is a very high speed differential input, complementary TTL output voltage comparator with improved characteristics over the μ A760/ μ A760C, for which it is a pin-for-pin replacement. The device has been optimized for greater speed, input impedance and fan-out, and lower input offset voltage. Typically delay varies only 3 ns for overdrive variations of 5 mV to 400 mV.

Complementary outputs having minimum skew are provided. Applications involve high speed analog to digital convertors and zero-crossing detectors in disk file systems.

Features

- Guaranteed high speed: 20 ns max
- Tight delay matching on both outputs
- Complementary TTL outputs
- High input impedance
- Low speed variation with overdrive variation
- Fan-out of 4
- Low input offset voltage
- Series 74 TTL compatible

Connection Diagrams

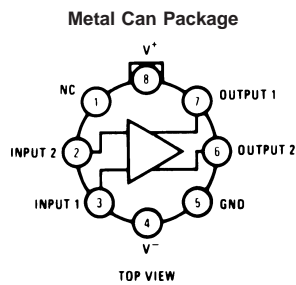

Order Number **LM160H/883** (Note 1) or **LM360H**
See NS Package Number **H08C**

Note 1: Also available in SMD# 5962-8767401

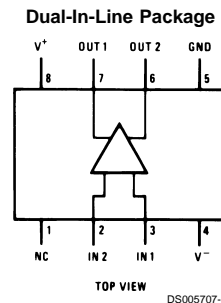

Order Number **LM360M** or **LM360N**
See NS Package Number **M08A** or **N08E**

Absolute Maximum Ratings (Notes 6, 8)

If Military/Aerospace specified devices are required, please contact the National Semiconductor Sales Office/Distributors for availability and specifications.

| | |
|-----------------------------|----------------------------|
| Positive Supply Voltage | +8V |
| Negative Supply Voltage | -8V |
| Peak Output Current | 20 mA |
| Differential Input Voltage | ±5V |
| Input Voltage | $V^+ \geq V_{IN} \geq V^-$ |
| ESD Tolerance (Note 9) | 1600V |
| Operating Temperature Range | |
| LM160 | -55°C to +125°C |
| LM360 | 0°C to +70°C |

| | |
|---|-----------------|
| Storage Temperature Range | -65°C to +150°C |
| Lead Temperature | |
| (Soldering, 10 sec.) | 260°C |
| Soldering Information | |
| Dual-In-Line Package | |
| Soldering (10 seconds) | 260°C |
| Small Outline Package | |
| Vapor Phase (60 seconds) | 215°C |
| Infrared (15 seconds) | 220°C |
| See AN-450 "Surface Mounting Methods and Their Effect on Product Reliability" for other methods of soldering surface mount devices. | |

Electrical Characteristics

($T_{MIN} \leq T_A \leq T_{MAX}$)

| Parameter | Conditions | Min | Typ | Max | Units |
|---|--|------|------|------|-------|
| Operating Conditions | | | | | |
| Supply Voltage V_{CC}^+ | | 4.5 | 5 | 6.5 | V |
| Supply Voltage V_{CC}^- | | -4.5 | -5 | -6.5 | V |
| Input Offset Voltage | $R_S \leq 200\Omega$ | | 2 | 5 | mV |
| Input Offset Current | | | 0.5 | 3 | μA |
| Input Bias Current | | | 5 | 20 | μA |
| Output Resistance (Either Output) | $V_{OUT} = V_{OH}$ | | 100 | | Ω |
| Response Time | | | | | |
| | $T_A = 25^\circ\text{C}, V_S = \pm 5\text{V}$ (Notes 2, 7) | | 13 | 25 | ns |
| | $T_A = 25^\circ\text{C}, V_S = \pm 5\text{V}$ (Notes 3, 7) | | 12 | 20 | ns |
| | $T_A = 25^\circ\text{C}, V_S = \pm 5\text{V}$ (Notes 4, 7) | | 14 | | ns |
| Response Time Difference between Outputs | | | | | |
| $(t_{pd} \text{ of } +V_{IN1}) - (t_{pd} \text{ of } -V_{IN2})$ | $T_A = 25^\circ\text{C}$ (Notes 2, 7) | | 2 | | ns |
| $(t_{pd} \text{ of } +V_{IN2}) - (t_{pd} \text{ of } -V_{IN1})$ | $T_A = 25^\circ\text{C}$ (Notes 2, 7) | | 2 | | ns |
| $(t_{pd} \text{ of } +V_{IN1}) - (t_{pd} \text{ of } +V_{IN2})$ | $T_A = 25^\circ\text{C}$ (Notes 2, 7) | | 2 | | ns |
| $(t_{pd} \text{ of } -V_{IN1}) - (t_{pd} \text{ of } -V_{IN2})$ | $T_A = 25^\circ\text{C}$ (Notes 2, 7) | | 2 | | ns |
| Input Resistance | $f = 1 \text{ MHz}$ | | 17 | | kΩ |
| Input Capacitance | $f = 1 \text{ MHz}$ | | 3 | | pF |
| Average Temperature Coefficient of Input Offset Voltage | $R_S = 50\Omega$ | | 8 | | μV/°C |
| Average Temperature Coefficient of Input Offset Current | | | 7 | | nA/°C |
| Common Mode Input Voltage Range | $V_S = \pm 6.5\text{V}$ | ±4 | ±4.5 | | V |
| Differential Input Voltage Range | | ±5 | | | V |
| Output High Voltage (Either Output) | $I_{OUT} = -320 \mu\text{A}, V_S = \pm 4.5\text{V}$ | 2.4 | 3 | | V |
| Output Low Voltage (Either Output) | $I_{SINK} = 6.4 \text{ mA}$ | | 0.25 | 0.4 | V |
| Positive Supply Current | $V_S = \pm 6.5\text{V}$ | | 18 | 32 | mA |
| Negative Supply Current | $V_S = \pm 6.5\text{V}$ | | -9 | -16 | mA |

Note 2: Response time measured from the 50% point of a 30 mVp-p 10 MHz sinusoidal input to the 50% point of the output.

Note 3: Response time measured from the 50% point of a 2 Vp-p 10 MHz sinusoidal input to the 50% point of the output.

Note 4: Response time measured from the start of a 100 mV input step with 5 mV overdrive to the time when the output crosses the logic threshold.

Note 5: Typical thermal impedances are as follows:

| | | | | | | |
|-----------------|---------------|---------|------------|---------------|---------|-----------------------|
| Cavity DIP (J): | θ_{JA} | 135°C/W | Header (H) | θ_{JA} | 165°C/W | (Still Air) |
| Molded DIP (N): | θ_{JA} | 130°C/W | | | 67°C/W | (400 LF/min Air Flow) |
| | | | | θ_{JC} | 25°C/W | |

Note 6: The device may be damaged if used beyond the maximum ratings.

Note 7: Measurements are made in AC Test Circuit, Fanout = 1

Note 8: Refer to RETS 160X for LM160H, LM160J-14 and LM160J military specifications.

Electrical Characteristics (Continued)

Note 9: Human body model, 1.5 kΩ in series with 100 pF.

Typical Performance Characteristics

Offset Voltage

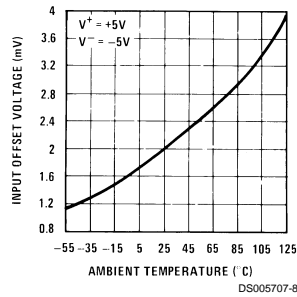

Input Current vs Ambient Temperature

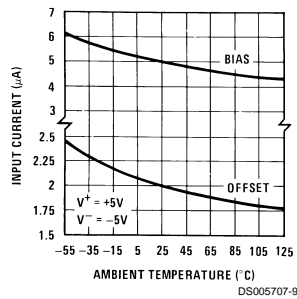

Input Characteristics

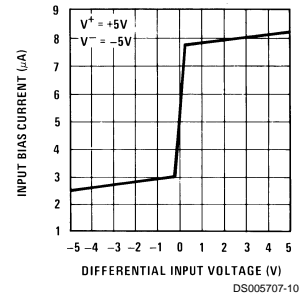

Supply Current vs Ambient Temperature

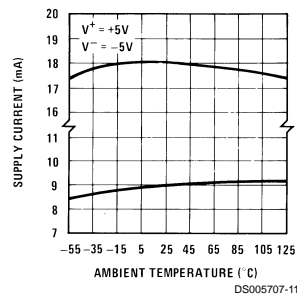

Propagation Delay vs Ambient Temperature

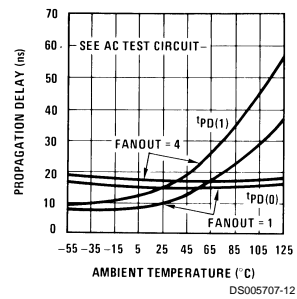

Delay of Output 1 With Respect to Output 2 vs Ambient Temperature

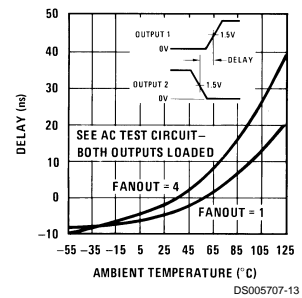

Common-Mode Pulse Response

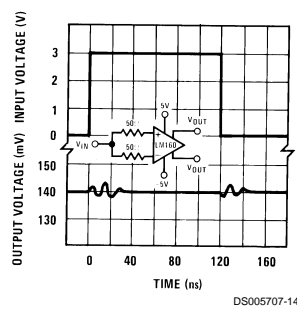

AC Test Circuit

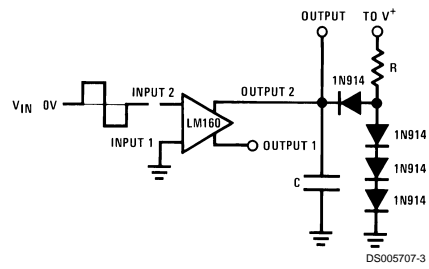

$V_{IN} = \pm 50 \text{ mV}$ FANOUT=1 FANOUT=4
 $V^+ = +5\text{V}$ $R = 2.4\text{k}$ $R = 630\Omega$
 $V^- = -5\text{V}$ $C = 15 \text{ pF}$ $C = 30 \text{ pF}$

Schematic Diagram

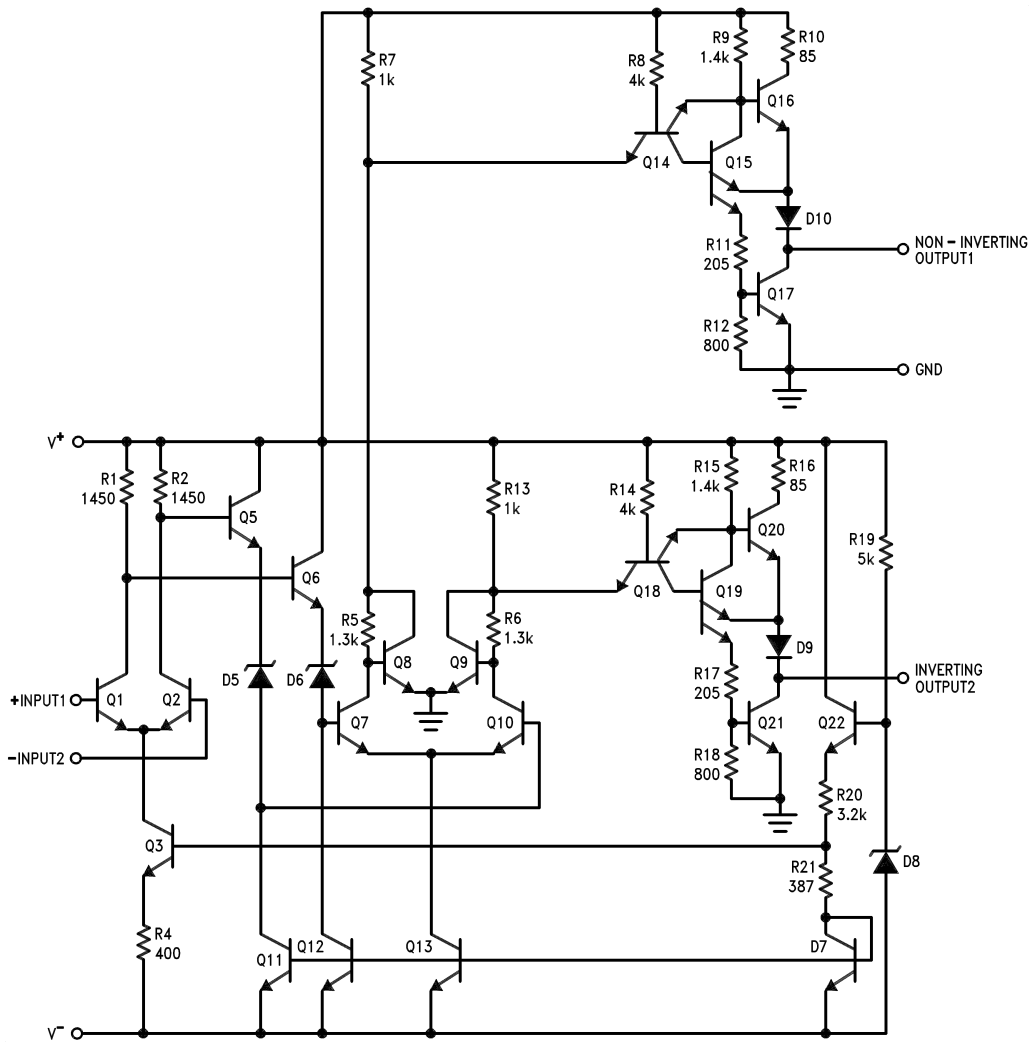

DS005707-1

Physical Dimensions inches (millimeters) unless otherwise noted

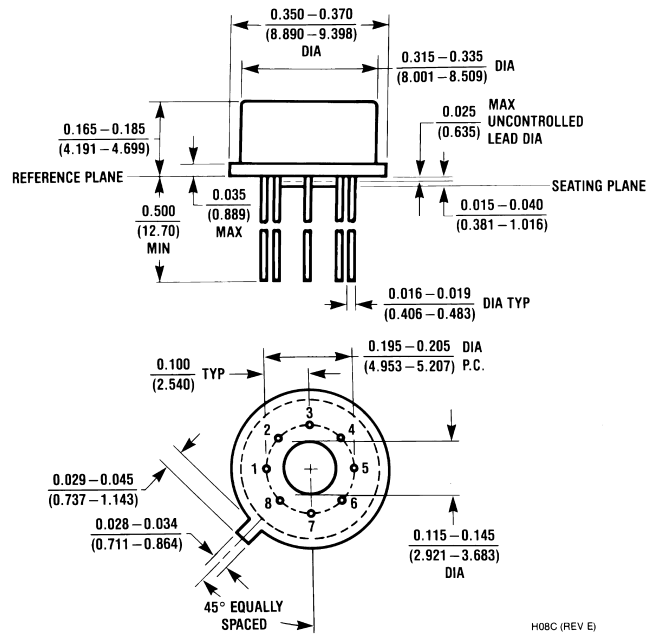

Metal Can Package (H)
Order Number LM160H/883 or LM360H
NS Package Number H08C

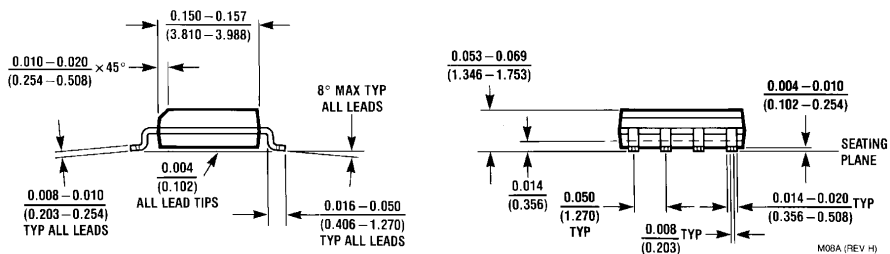
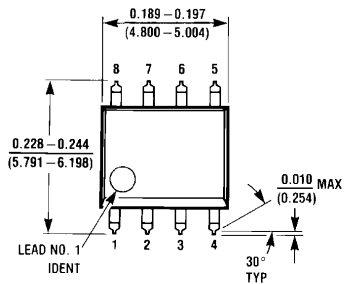

Molded Dual-In-Line Package (M)
Order Number LM360M
NS Package Number M08A

Physical Dimensions inches (millimeters) unless otherwise noted (Continued)

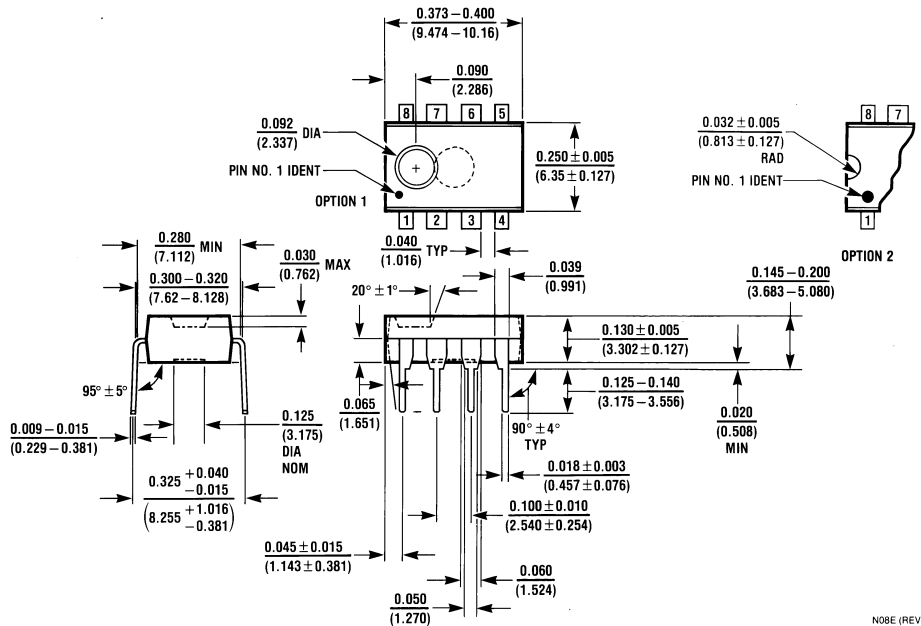

Molded Dual-In-Line Package (N)
Order Number LM360N
NS Package Number N08E

LIFE SUPPORT POLICY

NATIONAL'S PRODUCTS ARE NOT AUTHORIZED FOR USE AS CRITICAL COMPONENTS IN LIFE SUPPORT DEVICES OR SYSTEMS WITHOUT THE EXPRESS WRITTEN APPROVAL OF THE PRESIDENT AND GENERAL COUNSEL OF NATIONAL SEMICONDUCTOR CORPORATION. As used herein:

1. Life support devices or systems are devices or systems which, (a) are intended for surgical implant into the body, or (b) support or sustain life, and whose failure to perform when properly used in accordance with instructions for use provided in the labeling, can be reasonably expected to result in a significant injury to the user.
2. A critical component is any component of a life support device or system whose failure to perform can be reasonably expected to cause the failure of the life support device or system, or to affect its safety or effectiveness.

National Semiconductor Corporation
 Americas
 Tel: 1-800-272-9959
 Fax: 1-800-737-7018
 Email: support@nsc.com

National Semiconductor Europe
 Fax: +49 (0) 1 80-530 85 86
 Email: europe.support@nsc.com
 Deutsch Tel: +49 (0) 1 80-530 85 85
 English Tel: +49 (0) 1 80-532 78 32
 Français Tel: +49 (0) 1 80-532 93 58
 Italiano Tel: +49 (0) 1 80-534 16 80

National Semiconductor Asia Pacific Customer Response Group
 Tel: 65-2544466
 Fax: 65-2504466
 Email: sea.support@nsc.com

National Semiconductor Japan Ltd.
 Tel: 81-3-5639-7560
 Fax: 81-3-5639-7507

www.national.com